

OPERATORS' MANUAL

2101

20 GHz
MICROWAVE COUNTER

RACAL INSTRUMENTS LTD

RACAL

The Electronics Group



RACAL

A1404

Microwave Counter: 2101

HANDBOOK AMENDMENTS

Amendments to this handbook (if any), which are on coloured paper for ease of identification, will be found at the rear of the book. The action called for by the amendments should be carried out by hand as soon as possible.

TABLE OF CONTENTS

Paragraph	Title	Page
SECTION 1	TECHNICAL SPECIFICATION	1-1
SECTION 2	GENERAL DESCRIPTION	2-1
1	INTRODUCTION	2-1
2	MEASUREMENT FUNCTIONS	2-1
2	Frequency A Function	2-1
3	Frequency B Function	2-1
4	Frequency C Function	2-1
5	Ratio C/B Function	2-1
6	Ratio C/A Function	2-1
7	Ratio B/A Function	2-1
8	CHECK FUNCTION	2-2
9	SIGNAL INPUT CHANNELS	2-2
12	ADDITIONAL FREQ C ACQUISITION MODES	2-3
13	MATHS FUNCTIONS	2-3
14	SPECIAL FUNCTIONS	2-3
15	STORE/RECALL FUNCTIONS	2-3
16	SAMPLE RATE	2-3
17	ERROR INDICATION	2-4
18	DISPLAY FORMAT	2-4
19	HOLD FEATURE	2-4
20	RESOLUTION AND GATE TIME	2-4
21	EXTERNAL FREQUENCY STANDARD INPUT	2-4
22	STANDBY MODE	2-4
23	INITIALIZATION	2-4
24	GPIB INTERFACE	2-5
27	OPTIONS AVAILABLE	2-6
27	Frequency Standards (04X Options)	2-6
28	Reference Frequency Multiplier (Option 10)	2-6
29	Battery Pack (Option 07)	2-6
34	Rack Mounting Kits	2-7
SECTION 3	PREPARATION FOR USE	3-1
1	UNPACKING	3-1
3	POWER SUPPLY	3-1
3	AC Line Voltage Setting	3-1
5	Line Fuse	3-2
6	Power Cord	3-2
9	FUNCTIONAL CHECK	3-2
11	FREQUENCY STANDARD	3-3
13	PREPARATION FOR USE WITH THE GPIB	3-3
13	Introduction	3-3
14	Connection to the GPIB	3-3
15	Address Setting and Display	3-4

TABLE OF CONTENTS (Continued)

Paragraph	Title	Page
17	GPIB CHECK	3-4
20	Remote and Local Message Check	3-5
24	Local Lockout and Clear Lockout Check	3-7
27	Data Output Check	3-8
28	SRQ and Status Byte Check	3-9
30	IFC Check	3-10
31	TALK ONLY Selector Test	3-10
32	OPTION FITTING INSTRUCTIONS	3-10
32	Single-Instrument Fixed Rack Mounting Kit (Option 60A)	3-10
34	Double-Instrument Fixed Rack Mounting Kit (Option 60B)	3-11
37	Temperature Compensated Frequency Standard, 11-1713 (Option 04T)	3-12
40	Ovened Frequency Standards 11-1710 and 11-1711 (Options 04A and 04B)	3-13
43	Reference Frequency Multiplier Option 11-1645 (Option 10)	3-14
45	Battery Pack Option 11-1625 (Option 07)	3-15
47	Power Limiter Option 17-1103 (Option 11)	3-16
SECTION 4 OPERATING INSTRUCTIONS		4-1
1	INTRODUCTION	4-1
2	DESCRIPTION OF CONTROLS, INDICATORS AND CONNECTORS	4-1
2	Front Panel Items	4-1
3	Rear Panel Items	4-5
4	FREQUENCY MEASUREMENT - INPUT A	4-9
5	FREQUENCY MEASUREMENT - INPUT B	4-10
6	FREQUENCY MEASUREMENT - INPUT C	4-11
6	Normal Automatic Mode	4-11
7	Manual Mode	4-12
9	Further Functions in FREQ C (Automatic Mode Only)	4-12
11	Set LOW FM (FREQ C)	4-12
13	Set TRACK (FREQ C)	4-13
15	RATIO MEASUREMENTS C/B, C/A AND B/A	4-14
18	SAMPLE RATE	4-15
19	Setting and Using the Sample Rate	4-15
20	Displaying the Sample Rate	4-15
22	MULT FUNCTION	4-15
23	Setting the Multiplier	4-15
24	Enabling the Multiplier	4-16
26	Displaying the Multiplier	4-16
28	OFFSET FUNCTION	4-16
29	Setting the Offset	4-16
30	Enabling the Offset	4-17
32	Displaying the Offset	4-17

TABLE OF CONTENTS (Continued)

Paragraph	Title	Page
34	SMOOTH FUNCTION (SPECIAL FUNCTION 21)	4-17
35	DISPLAY RESOLUTION	4-17
38	GATE TIME	4-18
40	SPECIAL FUNCTIONS	4-19
41	Setting the Special Function Register	4-19
44	Enabling and Displaying the Special Functions	4-19
46	To recall Special Function Register	4-21
48	ERROR CODES	4-22
49	Clearing the Error Codes	4-22
50	USING THE BATTERY PACK OPTION	4-23
50	Power Supply Changeover	4-23
51	Battery-Low Indication	4-23
53	Operating Instructions	4-23
58	Battery Charging	4-24
SECTION 5 OPERATION VIA THE GPIB		5-1
1	INTRODUCTION	5-1
2	GPIB OPERATING MODES	5-1
3	TALK ONLY MODE	5-1
8	ADDRESSED MODE	5-2
10	DATA OUTPUT FORMAT - NORMAL	5-2
11	DATA OUTPUT FORMAT - DUMP MODES	5-2
13	SERVICE REQUEST	5-6
15	STATUS BYTE	5-6
16	SETTING THE ENABLE REGISTERS	5-6
22	EXPLANATION OF RESPONSE TO INTERFACE MESSAGES	5-11
24	Address Messages	5-11
28	Local Lockout	5-11
30	Device Clear and Selected Device Clear	5-11
32	Serial Poll Enable and Serial Poll Disable	5-13
35	Group Execute Trigger	5-13
36	Go to Local	5-13
37	Untalk and Unlisten	5-13
38	INPUT COMMAND CODES	5-13
39	MESSAGE PROTOCOL AND SYNTAX	5-14
41	System Message Traffic	5-14
44	Program Messages	5-15
47	Response Messages	5-15
50	White Space Character	5-15
51	OVERLAPPED/SEQUENTIAL COMMANDS	5-16

LIST OF TABLES

Table	Title	Page
3.1	GPIB Connector Pin Assignment	3-4
3.2	Address Switch Settings	3-6
4.1a	Gate Times for FREQUENCIES A and B	4-18
4.1b	Gate Times for FREQUENCY C	4-18
4.2	Major Special Functions... ..	4-19
4.3	Minor Special Functions... ..	4-20
4.4	Error Codes	4-22
5.1	Output Message Format... ..	5-3
5.2	Function Letters	5-4
5.3	Frequency C Dump	5-5
5.4	Frequency A and B Dump	5-5
5.5	Associated Registers	5-7
5.6	Status Byte and Service Request Enable Registers	5-8
5.7	Standard Event Status and Enable Registers	5-9
5.8	Device Defined Event Status and Enable Registers	5-10
5.9	Response to Bus Messages	5-12
5.10a	Common Commands	5-17
5.10b	Common Commands (Continued)	5-18
5.11a	Device Dependent Commands	5-19
5.11b	Device Dependent Commands (Continued)	5-20
5.11c	Device Dependent Commands (Continued)	5-21
5.11d	Device Dependent Commands (Continued)	5-22
5.11e	Device Dependent Commands (Continued)	5-23
5.11f	Device Dependent Commands (Continued)	5-24
5.11g	Device Dependent Commands (Continued)	5-25
5.12	Permitted Terminators	5-26
5.13	Numerical Input Format	5-27
5.14	Gate Times for FREQUENCIES A and B	5-28
5.15	Gate Times for FREQUENCY C	5-28
5.16	Special Function Codes	5-29
5.17	Special Function Request (SF?) Response Format	5-30
5.18	Alphabetic List of Required Command Codes	5-30
5.19	Alphabetic List of Optional Command Codes	5-31

SECTION 1

TECHNICAL SPECIFICATION

Technical Specifications

Input A

Frequency Range	10Hz to 100MHz
Sensitivity (rms)	20mV (to 80MHz) 30mV (at 100MHz)
Input Impedance	1M Ω /35pF
Maximum Input	260V (DC + AC rms) to 2kHz, decreasing to 10V rms at 50kHz and above
Filter	Low pass filter (50kHz)

Input B

Frequency Range	40MHz to 1.3GHz
Sensitivity	10mV (to 1GHz) 50mV (at 1.3GHz)
Input Impedance	50 Ω nominal
Operating Range	10mV to 5V rms
Damage Overload	7V rms (protected by fuse)
VSWR	<2.3 : 1 (1GHz)

Input C (Microwave Channel)

Frequency Range	500MHz to 20GHz
Sensitivity	-32dBm (to 12.4GHz) -27dBm (at 20GHz)
Operating Level	+7dBm
Damage Level	+25dBm peak (+33dBm with Option 11)
Input Connector	Precision type N female
VSWR	<2:1 (to 10GHz) <3:1 (to 20GHz)
AM Tolerance	Any modulation depth

FM Tolerance

Mode	Modulation Rate	FM Tolerance Max. Deviation
Automatic Normal Low FM Track	1kHz to 10MHz	20MHz pk-pk
	45Hz to 10MHz	20MHz pk-pk
	300kHz to 10MHz	20MHz pk-pk
Manual	1kHz to 10MHz	60MHz pk-pk*

* If set within ± 1 MHz

Acquisition Time

Mode	Acquisition Time
Automatic Normal Low FM Track	<125mSec
	<1.25mSec
	<60mSec
Manual	<20mSec

Tracking Speed

Mode	Tracking Speed
Normal Low FM Track	1MHz/Sec
	80kHz/Sec
	1GHz/Sec

Spilloverback Typically -55dBm
(-70dBm in quiet mode)

Amplitude Discrimination (Typical) 6dB for signals within 500MHz
20dB for signals at any frequency

IF Output

Available when measurements are made using Input C in Manual Mode. Available intermittently during gate time in Auto Mode.

Frequency Range 41MHz to 112MHz

Output Level -10dBm nominal

Output Impedance 50 Ω nominal

Reverse Damage Level 400V pk to 500Hz, decreasing to 10V rms at 30kHz and above

Measurement Modes

Frequency A and B

Range Frequency A 10Hz to 100 MHz

Range Frequency B 40MHz to 1.3GHz

Digits Displayed 3 to 10 digits

LSD Displayed (Hz) $F \times 10^{-D}$ (F=frequency rounded up to next decade, D=no. of digits)

Resolution (Hz) $\pm \text{LSD} \pm \left[\frac{1.4 \times \text{Trig Error}^*}{\text{Gate Time}} \right] \times \text{Ratio}$

Accuracy (Hz) $\pm \text{Resolution}$
 $\pm (\text{Timebase Error} \times \text{Freq})$

Frequency C

Range 500MHz to 20GHz

LSD Display (Resolution) 0.1Hz to 1MHz (selectable)

Accuracy $\pm \text{Resolution}$
 $\pm \text{Timebase error} \times \text{Frequency}$
 $\pm \text{Residual stability}^*$

Ratio B/A, C/A, C/B

Software Ratios. (Hardware ratio also available for B/A using SF91)

Range (B/A) 40MHz to 1.3GHz
10Hz to 80MHz

Range (C/A) 500MHz to 20GHz
10Hz to 80MHz

Range (C/B) 500MHz to 20GHz
40MHz to 1.3GHz

LSD Displayed $R \times 10^{-D}$
(R=Ratio rounded up to next decade, D=number of digits)

Resolution (ppm) Sum of the 2 resolutions expressed in ppm

Accuracy (ppm) Sum of the 2 accuracies expressed in ppm

Check 10MHz frequency standard displayed

Features

Manual

For fastest measurement and data output rates, Manual Mode suspends automatic operation and microprocessor calculates optimum internal local oscillator frequency and harmonic number from a user-entered centre frequency

NB user enters centre frequency to within $\pm 20\text{MHz}$ of input frequency ($\pm 3\text{MHz}$ below 1GHz)

Low FM

For accepting very low modulation rates

Track

Track mode selects the fastest possible acquisition cycle and tracks the movement of fast moving input frequencies

Maths

Multiply

Displays the measured frequency multiplied by an entered number

Offset

Allows a stored or keyboard entered frequency to be added or subtracted from the measured signal

Smooth

Displays the optimum resolution relevant to the stability of the input signal

GPIB

GPIB Interface

Designed to comply with IEEE-STD-488.1(1987) and IEEE-STD-488.2(1987)

Control Capability

All functions/controls programmable except power on/off and standby/charge

Output

Engineering format having 12 digits and exponent

Read Rate

5 to 18 per Sec. dependant on measurement function. Faster dump mode available

IEEE-STD-488 Subsets

SH1, AH1, T5, TE0, L4, LE0, SR1, RL1, PPO, DC1, DT1, CO, E2

* n=1 for 3-5 and 10 digits or 2 for 6-9 digits

* See definitions

Timebase Specifications

Internal Timebase (PX0)

Frequency	10MHz
Aging Rate	2×10^{-6} in the first year
Temp. Stability	1×10^{-5} over 0-50°C range

Frequency Standard Output

Frequency	10MHz
Amplitude	TTL levels giving approximately 1V pk-pk into 50Ω

External Standard Input

Frequency	10MHz (see also Option 10)
Signal Range	100mV rms to 10V rms
Damage Level	10V rms
Input Impedance	1kΩ nominal for signals <1V pk-pk 500Ω nominal for signals ≥10V pk-pk
Coupling	AC coupled

General Specifications

Single Cycle (Hold)	Enables a single measurement to be initiated and held
Gate Times	Automatically determined depending on resolution selected
Range	1mSec to 20Sec (10 Sec maximum for channel C)
Sample Rate	Selectable display and data output rates
Display	13 digit high brightness 14mm LED display. Separate indicators for GHz, MHz, kHz and Hz

Power Requirements

Voltage	90 to 127V, 193 to 253V (externally selectable)
Frequency	45 to 440Hz
Power Rating	40VA max
Operating Temp. Range	0 to 50°C 0 to 40°C (with batteries)
Storage Temp. Range	-40 to +70°C -40 to +60°C (with batteries)
EMC/RFI	Meets the requirements of MIL-STD-461 RE02 to 1.3GHz and CE03
Safety	Designed to meet the requirements of IEC348 and follow the guidelines of UL1244
Weight	Net 5.5kg excluding battery Net 8.4kg including battery
Normal Dimensions	See back page
Shipping Dimensions	260mm (H) x 355mm (W) x 610mm (D)

Options

Option 01 Rear Panel Inputs

Connections to input channels A, B and C can be made at rear.

Option 04T Temperature Compensated Crystal Oscillator

Frequency	10MHz
Aging Rate	3×10^{-7} per month 1×10^{-6} in the first year
Temp. Stability	1×10^{-6} over the range 0°C to +40°C (Operable to +50°C)

Option 04A Ovened Oscillator

Frequency	10MHz
Aging Rate	3×10^{-9} per day averaged over 10 days after 3 months continuous operation
Temp. Stability	$\pm 3 \times 10^{-9}$ per °C averaged over the range 0°C to +45°C (operable to +50°C)

Option 04B High Stability Ovened Oscillator

Frequency	10MHz
Aging Rate	5×10^{-10} per day averaged over 10 days after 3 months continuous operation
Temp. Stability	$\pm 6 \times 10^{-10}$ per °C averaged over range 0°C to +45°C (operable to +50°C)

Option 07 Rechargeable Battery Pack and External DC Operation

Battery Life	Up to 30 hours on battery save/standby (typical 3 hours continuous at 25°C)
Battery Condition	Display indicates battery low
External DC	11 to 16V via socket on rear panel

Option 10 Reference Frequency Multiplier

Input Frequency	1,2,5 or 10MHz ($\pm 1 \times 10^{-5}$)
-----------------	---

Option 11 Power Limiter

Fitted internally to increase Input C protection

Max. CW power	+36dBm to 18GHz decreasing to +33dBm at 20GHz
Sensitivity Loss	3 to 4dB depending on frequency

Note: further options/accessories listed on back page.

Definitions

Trigger Error rms

$$\text{Trigger Error} = \frac{[E_i^2 + E_n^2]^{1/2}}{\text{Slew rate at Trigger Point (V/Sec)}}$$

E_i = Input amplifier rms noise
(typically 100µV rms in 100MHz bandwidth)

E_n = Input signal rms noise in 100MHz bandwidth

Residual Stability (channel C only)

Residual stability (rms) = 1 LSD for resolutions 0.1Hz to 1kHz, negligible above 1kHz

Software Ratio Measurements

Counter measures denominator first according to the number of digits selected. It then measures the numerator with the same value of LSD, subject to the maximum resolution possible.

ORDERING INFORMATION

2101	20GHz Microwave Counter (includes GPIB)
-------------	---

OPTIONS AND ACCESSORIES

01*	Rear Panel Inputs	11-9010
04T**	TCXO	11-1713
04A**	Oven Oscillator	11-1710
04B**	High Stability Oven Oscillator	11-1711
07 §	Battery Pack (includes handles)	11-9009
10	Reference Frequency Multiplier	11-1645
11	Input Power Limiter	11-9011

60	Handles	11-1730
60A	Rack Mounting Kit (Fixed Single)	11-1648
60B***	Rack Mounting Kit (Fixed Double)	11-1649
61	Carrying Case	15-7001
61M	Protectomuff Case	15-7000
65	Chassis Slides (inc. Rack Mounts)	11-1716
68	Telescopic Antenna	23-9020
69	1.3GHz Fuse (Pkt 5)	11-1718
93	High Impedance 100MHz Probe	23-9104

- § The battery pack option replaces the GPIB normally fitted.
- * Fitting Option 01 may affect certain input specifications and Option 11 now external.
- ** Only one frequency standard may be fitted at any one time. The standard reference will be supplied unless Option 04T, 04A or 04B is specified.
- *** For use with 1990 Series Counter. The 2101 must be at left side of rack.

SUPPLIED ACCESSORIES

Power Cord
Spare Fuse
Operator's Manual
Spare 1.3GHz Fuse

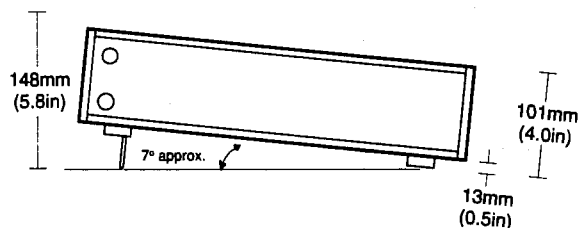
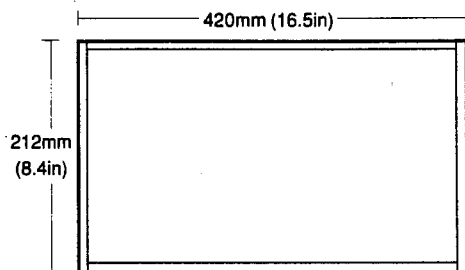

With Optional Handles Fitted

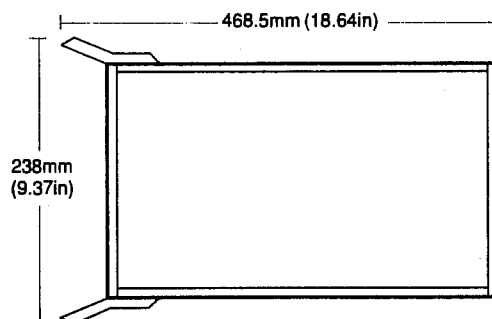

INTRODUCTION

- 1 The Racal-Dana microwave counter Model 2101 is a microprocessor-controlled instrument offering high-accuracy measurements with a comprehensive range of facilities. These facilities include Automatic/Manual Operation, Tracking, Offset, Multiply, and Store and Recall.

MEASUREMENT FUNCTIONS

Frequency A Function

- 2 The Frequency A Function is used to measure the frequency of the signal applied to INPUT A. A resolution of up to ten digits can be selected with a gate time of 1 millisecond to 20 seconds depending on the resolution selected.

Frequency B Function

- 3 The Frequency B Function is used to measure the frequency of the signal applied to INPUT B. A resolution of up to ten digits can be selected with a gate time of 1 millisecond to 20 seconds depending on the resolution selected.

Frequency C Function

- 4 The Frequency C Function is used to measure the frequency of the signal applied to INPUT C. A resolution of 0.1 Hz to 1 MHz can be selected with a gate time of 1 millisecond to 10 seconds depending on the resolution selected and frequency being sampled.

Ratio C/B Function

- 5 The Ratio C/B Function is used to measure the ratio of the frequency applied to INPUT C to that applied to INPUT B.

Ratio C/A Function

- 6 The Ratio C/A Function is used to measure the ratio of the frequency applied to INPUT C to that applied to INPUT A.

Ratio B/A Function

- 7 The Ratio B/A Function is used to measure the ratio of the frequency applied to INPUT B to that applied to INPUT A.

CHECK FUNCTION

- 8 The check function measures and displays the internal standard frequency to confirm counter operation. With the CHECK function selected a number of functional tests of the instrument's circuits can be made without the use of additional test equipment (Special Functions 71 to 75). Although these tests do not check the instrument's performance to its published specification, they can be used to verify that the instrument is operating correctly.

SIGNAL INPUT CHANNELS

- 9 Signal input channels A, B and C are fully independent.

The main characteristics of INPUT A are as follows:

- (1) Frequency range of 10 Hz to 80 MHz.
- (2) BNC input connector
- (3) Input impedance of 1 MegOhm.
- (4) Damage overload of 260 V (DC & AC r.m.s.) to 2 kHz, reducing to 10 V r.m.s. at 50 kHz and above.
- (5) 50 kHz Low Pass Filter. Enabled using Special Function 11.

- 10 The main characteristics of INPUT B are as follows:

- (1) Frequency range of 40 MHz to 1.3 GHz.
- (2) BNC input connector (Fused).
- (3) Input impedance of 50 Ohms.
- (4) Damage overload of +29 dBm protected by the fuse inside the input connector.

- 11 The main characteristics of INPUT C are as follows:

- (1) Frequency range of 500 MHz to 20 GHz;
- (2) Input connector - Type N;
- (3) Input impedance of 50 Ohms.
- (4) Damage overload of +25 dBm peak.

ADDITIONAL FREQ C ACQUISITION MODES

- 12 (1) **MANUAL** - This function is used to override the automatic acquisition cycle of FREQ C. It enables the user to manually enter a center frequency and achieve the fastest possible read rates.
- (2) **LOW FM** - When enabled this function selects an extended acquisition time to enable frequency readings of signals with low modulation rates. This function is only used during FREQ C measurements.
- (3) **TRACK** - When enabled this function selects the fastest possible auto-acquisition cycle to enable swept-frequency readings. This function is only used during FREQ C measurements.

MATHS FUNCTIONS

- 13 (1) **MULT** - When activated this function scales readings by the factor stored in the 'MULT' store.
- (2) **OFFSET** - When activated this function displays the difference between the measured value and the number held in the 'OFFSET' store.
- (3) **SMOOTH** - This is a Special Function (SF 21). Selecting SMOOTH causes the counter to take a running average of the input frequency and display those digits that are stable. Place-holding zeros (in the form of half-height zeros) are used in place of unstable digits.

SPECIAL FUNCTIONS

- 14 **SF** - This function preselects special functions and enables them.

STORE/RECALL FUNCTIONS

- 15 (1) **STORE** - This function enables the operator to store data in specific stores.
- (2) **RECALL** - This function enables the operator to recall the contents of specific stores.
- (3) **MHz** - This function is a 10^6 multiplier, used when entering numbers into stores.
- (4) **+/-** - This function is used to control the sign of entered numbers.

SAMPLE RATE

- 16 **SAMPLE** - This function is continuously enabled and controls the display sample rate.

ERROR INDICATION

- 17 Certain errors in the operation of the instrument will result in the generation of error codes which will be displayed. Details are given in Section 4 of this manual.

DISPLAY FORMAT

- 18 A 13 digit numeric (13 x 7 segment) display with units annunciators is used. An overflow of the most significant digit can be used to further increase the display resolution.

HOLD FEATURE

- 19 The Hold feature allows readings to be held indefinitely. A new measurement cycle is initiated using the RESET key.

RESOLUTION AND GATE TIME

- 20 The gate time is determined by the display resolution selected. Details of the relationship between gate time and display resolution for each measurement mode are given in Section 4 of this manual.

EXTERNAL FREQUENCY STANDARD INPUT

- 21 The instrument may be operated using an external frequency standard. The instrument will operate from the external standard, in preference to the internal standard, whenever the signal at the EXT. STD. INPUT socket is of sufficient amplitude. It will revert to operation from the internal standard automatically if the input from the external standard is removed.

STANDBY MODE

- 22 When the instrument is switched to standby, the internal frequency standard continues to operate and the instrument status is maintained but the measuring circuits are switched off. If the battery pack is fitted and an external power supply is connected, the battery is charged at the full rate.

INITIALIZATION

- 23 When the instrument is first switched on, or when it is initialized via the GPIB, it will perform the following:
- (1) A software and hardware check. Error messages will be displayed if a fault is found.

- (2) The display will then show the unit number for two seconds, i.e. 2101.
- (3) The display will then show the software number for two seconds.
- (4) The instrument will then set itself to the following state:

FUNCTION	STATE
(a) STANDBY/NORMAL	NORMAL
(b) MEASUREMENT MODE	FREQ C
(c) RESOLUTION	1 Hz
(d) MANUAL	OFF (Store value: 1 GHz)
(e) SF	OFF (Store value: 10, 20, 30, 40, 50, 60, 70, 80, 90)
(f) MULT	OFF (Store value: 1)
(g) OFFSET	OFF (Store value: 0)
(h) SAMPLE RATE	OPTIMUM (Store value: 0)
(j) LOW FM	OFF
(k) TRACK	OFF
(l) HOLD	OFF

GPIB INTERFACE

- 24 An internally mounted interface to the IEEE-488.2-GPIB is fitted to the instrument as standard. This permits remote control of all the instruments functions except the power ON/OFF switching and the STANDBY/CHARGING facility.

NOTE: If the instrument is ordered with a Battery Pack Option, then a GPIB is not fitted. However, the Battery Pack Option can be removed and a GPIB fitted in its place.

- 25 On switch-on the instrument will set itself to the following state:

(m) LO Store (for SF41)	340 MHz
(n) HN Store (for SF41)	-37
(o) GPIB DUMP Mode	OFF

(p) GPIB F.P. Commands ON

(q) GPIB Enable Register 0

- 26 An adaptor, Racal-Dana part number 23-3254, is available as an accessory to convert the connector to the IEC 625-1 standard.

OPTIONS AVAILABLE

Frequency Standards (04X Options)

- 27 A wide range of internal frequency standard options is available. The technical specifications are given in Section 1 of this manual. The frequency standard can be changed, if required, by the customer: instructions are given in Section 3.

Reference Frequency Multiplier (Option 10)

- 28 The reference frequency multiplier is an internally-mounted, phase-locked multiplier, which permits the use of external frequency standard signals at 1 MHz, 2 MHz, 5 MHz or 10 MHz. The multiplier can be fitted by the customer: instructions are given in Section 3.

Battery Pack (Option 07)

- 29 Fitting the internal Battery Pack Assembly permits the instrument to be used in locations where no suitable AC supply is available. The option also allows operation from an external DC supply.
- 30 The battery is trickle-charged whenever the instrument is operated from an AC supply and the INTERNAL/EXTERNAL switch is at INTERNAL BATTERIES. Charging at the full rate is carried out when the instrument is switched to the standby mode and connected to an external AC or DC supply. A full charge requires approximately 14 hours.
- 31 The instrument will operate continuously from a fully-charged battery for approximately two hours (30 hours in standby). It will switch off automatically when the battery reaches the discharged condition. The STBY/CHRG indicator starts to flash approximately 15 minutes before this occurs. The battery life can be significantly extended by use of the Battery Save facility.
- 32 The Battery Pack option contains a switchable Battery Save function. When in this mode and not connected to an external supply, the instrument times out into STANDBY mode after one minute. Pressing the STBY key will return the instrument to operational mode.
- 33 The battery pack can be fitted by the customer: instructions are given in Section 3 (See NOTE).

NOTE: This option cannot be installed in instruments that are fitted with the GPIB Interface, without first removing the GPIB Interface from the instrument.

Rack Mounting Kits

34 The following kits permitting the instrument to be mounted in a standard 19-inch rack are available:

(1) Single instrument, fixed-mount kit (Option 60A).
(Racal-Dana part number 11-1648).

The mounted instrument occupies half the rack width and is two rack units (3.5 inches) in height. The instrument is mounted offset in the rack and may be at either side.

(2) Double instrument, fixed mount kit (Option 60B).
(Racal-Dana part number 11-1649).

The panel of the mounting kit occupies the full width of the rack and is two rack units (3.5 inches) in height.

CAUTION: TWO 2101s CANNOT BE MOUNTED SIDE-BY-SIDE. IF MOUNTING A 2101 IN A DOUBLE INSTRUMENT MOUNTING KIT, IT MUST BE MOUNTED TO THE LEFT OF THE RACK TO ALLOW FREE AIRFLOW THROUGH THE INSTRUMENT COOLING FAN.

35 All the kits can be fitted by the customer: instructions are given in Section 3.

SECTION 3

PREPARATION FOR USE

UNPACKING

- 1 Unpack the instrument carefully to avoid unnecessary damage to the factory packing.
- 2 If it becomes necessary to return the instrument to Racal-Dana Instruments for calibration or repair, the original packaging should be used. If this is not possible, a strong shipping container should be used. Ensure that sufficient internal packing is used to prevent movement of the instrument within the container during transit.

POWER SUPPLY

AC Line Voltage Setting

- 3 Before using the instrument, check that the AC voltage selector is set correctly for the local AC supply. The setting in use can be seen through a window in the hinged cover of the line input plug.
- 4 If it is necessary to change the setting, proceed as follows:
 - (1) Switch off the AC supply and remove the power cord.
 - (2) Using a 0.25 inch flat-bladed screwdriver, prise open the hinged cover.
 - (3) Remove the voltage setting drum.
 - (4) Withdraw the fuse carrier by pulling the end, marked with an arrow, straight out of the aperture.
 - (5) Ensure that the fuse fitted is suitable for the voltage range in use (see 'Line Fuse').
 - (6) Replace the fuse and carrier. Ensure the arrow on the fuse carrier points in the same direction as those on the underside of the cover.
 - (7) Replace the voltage setting drum so that the required setting is outermost.
 - (8) Close the hinged cover and ensure that the required setting is visible in the window.
 - (9) Reconnect the power cord.

Line Fuse

- 5 Check that the rating of the line fuse is suitable for the AC voltage range in use. The fuse should be of the 5 mm x 20 mm, glass cartridge, surge-resisting type. The required rating is:

90 V to 127 V: 500 mA (Racal-Dana part number 23-0022).
193 V to 253 V: 315 mA (Racal-Dana part number 23-0032).

Power Cord

- 6 The 2101 is a Safety Class 1 instrument, and is designed to meet international safety standards. A protective ground terminal, which forms part of the power-input connector on the rear panel, is provided. The instrument is provided with a three-core power cord. Only the power cord supplied should be used to make electrical connection to the power-input connector.
- 7 AC power for the instrument must be taken from a power outlet incorporating a protective ground connector. When the green/yellow conductor of the power cord is joined to this connector the exposed metalwork of the instrument is grounded. The continuity of the protective ground connection must not be broken by the use of two-core extension cords or three-prong to two-prong adapters.
- 8 Connection of the power cord to the power outlet must be made in accordance with the standard color code as follows:

AC Supply	European	American
Line	Brown	Black
Neutral	Blue	White
Ground (Earth)	Green/Yellow	Green

FUNCTIONAL CHECK

- 9 The functional check tests the operation of many of the instrument's circuits to establish whether the instrument is functioning correctly. The procedure should be followed when the instrument is first taken into use, and after transportation to a new location. It does not check that the instrument is operating to the published specification. Detailed specification tests are given in Section 7 of the Maintenance Manual.
- 10 (1) Connect the instrument to a suitable AC supply.
- (2) Switch the instrument on. Check that the instrument type-number appears in the display for approximately two seconds, followed by a number which indicates the software version and issue number for approximately two seconds. The instrument will then set itself to the initialized state.

- (3) Press the **FUNCTION** ↓ key until the **CHECK** indicator lights. Check that the display shows 10.000 000 00 and the **GATE** indicator is flashing.
- (4) Press the **RESOLUTION** ↓ key six times, ensuring that the resolution of the display is decreased by one digit each time.
- (5) Press the **RESOLUTION** ↑ key six times, ensuring that the display resolution of the display is increased by one digit each time.
- (6) Switch the instrument off.

FREQUENCY STANDARD

- 11 If it is intended to use an external frequency standard, the frequency standard should be connected to the **EXT. STD. INPUT** connector on the rear panel of the instrument. The connection should be made using coaxial cable. Switch on the frequency standard and the instrument: check that the **EXT STD** indicator on the front panel of the instrument lights.
- 12 A 10 MHz signal, derived from the standard in use, is available at the **10 MHz STD OUTPUT** connector on the rear panel of the instrument. If this signal is used, the connection should be made using coaxial cable.

PREPARATION FOR USE WITH THE GPIB

Introduction

- 13 The instrument must be prepared for use in accordance with the instructions given in the section titled "**POWER SUPPLY**" before the instructions in this section are implemented.

Connection to the GPIB

- 14 Connection to the GPIB is made via a standard IEEE-488 connector mounted on the rear panel. The pin assignment is given in TABLE 3.1. An adaptor, Racal-Dana part number 23-3254, to convert the connector to the IEC 625-1 standard is available as an optional accessory.

TABLE 3.1

GPIB Connector Pin Assignment

Pin	Signal Line	Pin	Signal Line
1	DIO 1	13	DIO 5
2	DIO 2	14	DIO 6
3	DIO 3	15	DIO 7
4	DIO 4	16	DIO 8
5	EOI	17	REN
6	DAV	18	Gnd (6)
7	NRFD	19	Gnd (7)
8	NDAC	20	Gnd (8)
9	IFC	21	Gnd (9)
10	SRQ	22	Gnd (10)
11	ATN	23	Gnd (11)
12	SHIELD	24	Gnd (5 & 17)

Address Setting and Display

- 15 The interface address is set using five switches, A1 to A5, which are mounted on the rear panel. The permitted address settings, in binary, decimal and ASCII character form are given in TABLE 3.2. The GPIB address can be displayed, in decimal form, by pressing:

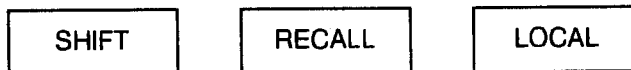

If the address is changed, this key sequence must be repeated to display the new address. The instrument is returned to the measurement mode by pressing:

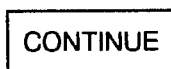

- 16 For addressed operation, the TALK ONLY switch must be in the logic '0' position (down). When this switch is in the logic '1' position, the interface is switched to the talk-only mode. The setting of switches A1 to A5 are then irrelevant.

GPIB CHECK

- 17 The procedure which follows checks the ability of the instrument to accept, process and send GPIB messages. The correct functioning of the instrument under local control should be verified before the procedure is attempted.

- 18 The recommended test equipment is the Hewlett-Packard HP-85 GPIB controller, with the I/O ROM in the drawer. It is assumed that the select code of the controller I/O port is 7, and that the address of the instrument is 17 (to change the address see 'Address Setting and Display'). If any other controller or select code/address combination is used, the GPIB commands given in the following paragraphs will require modification. The controller should be connected to the GPIB interface of the instrument via a GPIB cable. No connection should be made to INPUTs A, B or C.
- 19 Successful completion of the GPIB check proves that the instrument's GPIB interface is operating correctly. The procedure does not check that all the device-dependent commands can be executed. However, if the GPIB interface works correctly and the instrument operates correctly under local control, there is a high probability that it will respond to all device-dependent commands.

Remote and Local Message Check

- 20 Switch the GPIB controller and instrument on. Check that the REM, ADDR and SRQ indicators flash on and off once. If the indicators do not flash, or if they flash continuously, there is a fault on the GPIB board.
- 21 Test as follows:

Action	HP-85 Code	Your Controller
Send the REN message true, together with the instrument's listen address.	REMOTE 717	

Check that the REM indicator lights.

- 22 Test as follows:

Action	HP-85 Code	Your Controller
Send the device dependent command CHECK.	OUTPUT 717; "CHECK"	

Check that the ADDR indicator lights and that the Check mode is selected.

TABLE 3.2
Address Switch Settings

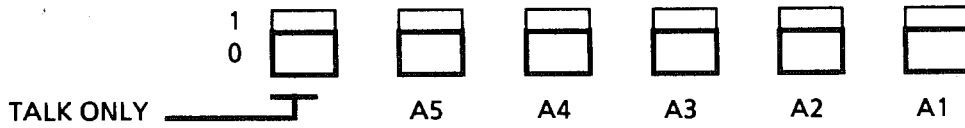

Switch Settings					Address Codes		
					Decimal	ASCII Listen Address	ASCII Talk Address
A5	A4	A3	A2	A1			
0	0	0	0	0	0	SP	@
0	0	0	0	1	1	!	A
0	0	0	1	0	2	"	B
0	0	0	1	1	3	#	C
0	0	1	0	0	4	\$	D
0	0	1	0	1	5	%	E
0	0	1	1	0	6	&	F
0	0	1	1	1	7	'	G
0	1	0	0	0	8	(H
0	1	0	0	1	9)	I
0	1	0	1	0	10	*	J
0	1	0	1	1	11	+	K
0	1	1	0	0	12	,	L
0	1	1	0	1	13	-	M
0	1	1	1	0	14	.	N
0	1	1	1	1	15	/	O
1	0	0	0	0	16	0	P
1	0	0	0	1	17	1	Q
1	0	0	0	1	18	2	R
1	0	0	1	1	19	3	S
1	0	1	0	0	20	4	T
1	0	1	0	1	21	5	U
1	0	1	1	0	22	6	V
1	0	1	1	1	23	7	W
1	1	0	0	0	24	8	X
1	1	0	0	1	25	9	Y
1	1	0	1	0	26	:	Z
1	1	0	1	1	27	;	[
1	1	1	0	0	28	<	/
1	1	1	0	1	29	=]
1	1	1	1	0	30	>	^

Instrument shipped with this setting

23 Test as follows:

Action	HP-85 Code	Your Controller
Send the instrument's listen address followed by the GTL message.	LOCAL 717	

Check that the REM indicator is off. The ADDR indicator will also be off if the controller used sends the unlisten message (UNL) true automatically. This happens when using the HP-85.

Local Lockout and Clear Lockout Check

24 Test as follows:

Action	HP-85 Code	Your Controller
Send the REN message true, together with the instrument's listen address	REMOTE 717	
Send the LLO message	LOCAL LOCKOUT 7	

Check that the REM indicator lights. Operate the LOCAL key on the front panel and verify that the REM indicator remains lit.

25 Test as follows:

Action	HP-85 Code	Your Controller
Send the REN message false	LOCAL 7	

Check that the REM indicator is off.

6 Test as follows:

Action	HP-85 Code	Your Controller
Send the REN message true, together with the instrument's listen address	REMOTE 717	

Check that the REM indicator lights. Press the LOCAL key and verify that the REM indicator turns off.

Data Output Check

27 Test as follows:

Action	HP-85 Code	Your Controller
Set the instrument to the check mode by sending the listen address, followed by the device dependent command CHECK.	OUTPUT 717 "CHECK; MEAS?"	
Prepare a store to receive a 22 byte string.	DIM Z\$ [22]	
Send the instrument's talk Address. Store the 22-byte data string in the prepared store.	ENTER 717; Z\$	
Display the contents of the store.	DISP Z\$	

Check that the controller displays CK + 00010.00000000E + 06 with the cursor moved to the next line, indicating that the line feed (LF) and END/OR Identity (EOI) have been accepted.

SRQ and Status Byte Check

28 Test as follows:

Action	HP-85 Code	Your Controller
Send the REN message true.	REMOTE 717	
Set the instrument to generate the SRQ message on receipt of a command error.	OUTPUT 717; "*ESE 32;*SRE 32"	
Set the instrument to send the SRQ message when an error is detected, and force the generation of a command error by sending the non-existent device-dependent command XXX.	OUTPUT 717; "XXX"	
Store the status of the GPIB interface of the controller, in binary form, as variable T.	STATUS 7, 2; T	
Display the status of the SRQ line.	DISP"SRQ = ";BIT (T,5)	

Check that the controller displays SRQ = 1, the SRQ status bit is at logic 1 or the SRQ line is less than or equal to 0.8 V. Check that the SRQ indicator on the instrument is lit.

29 Test as follows:

Action	HP-85 Code	Your Controller
Conduct a serial poll and store the status byte as variable R.	R = SPOLL (717)	
Display variable R.	DISP"R = "; R	

Check that the SRQ indicator is turned off when the serial poll is made. The value of R should be 91 (in binary form, R should be 01100000). If using the HP-85 controller, check that the ADDR indicator on the instrument is turned off.

IFC Check

30 Test as follows:

Action	HP-85 Code	Your Controller
Send the ATN message false	RESUME 7	
Send the IFC message false	ABORTIO 7	

Check that the ADDR indicator is turned off.

TALK ONLY Selector Test

- 31 (1) Set the TALK ONLY switch on the instrument rear panel to '1'. Check that the REM indicator is turned off and the ADDR indicator lights.
- (2) Set the TALK ONLY switch to '0'. Check that the ADDR indicator is turned off.

OPTION FITTING INSTRUCTIONS

Single-Instrument Fixed Rack Mounting Kit 11-1648 (Option 60A)

32 The kit comprises:

Item	Qty	Racal-Dana Part Number
Short mounting bracket	1	16-0643
Long mounting bracket	1	16-0644
Screw, M4 x 16	4	24-7733
Crinkle washer M4	4	24-2802
Spacer, plain M4 x 5	4	24-4112
Screw, M6 x 16	4	24-7795
Cup washer, M6	4	24-2809
Caged nut, M6	4	24-2240

33 Assemble the kit to the instrument as follows:

- (1) Disconnect the AC power cord at the rear panel.
- (2) Remove the two screws which secure the bezel to the rear panel; remove the bezel.
- (3) Remove the bottom cover by sliding it towards the rear of the instrument.
- (4) Remove the instrument's feet from the bottom cover and retain them for future use.
- (5) Replace the bottom cover. Replace and secure the bezel.

- (6) Remove the four blind grommets from the sides of the instrument. This will reveal two threaded holes in each side frame.
- (7) At one side of the instrument, secure a mounting bracket to the side frame, using two spacers, M4 screws and crinkle washers. Position the spacers between the mounting bracket and the side frame.
- (8) Repeat step (7) at the other side of the instrument.
- (9) Fit the cup washers to the M6 screws. Offer the instrument up to the required position, and secure the brackets to the rack using the M6 screws and nuts.

Double-Instrument Fixed Rack Mounting Kit 11-1649 (Option 60B)

CAUTION: TWO 2101s CANNOT BE MOUNTED SIDE-BY-SIDE. IF MOUNTING A 2101 IN A DOUBLE INSTRUMENT MOUNTING KIT, IT MUST BE MOUNTED TO THE LEFT OF THE RACK TO ALLOW FREE AIRFLOW THROUGH THE INSTRUMENT COOLING FAN.

34 The kit comprises:

Item	Qty	Racal-Dana Part Number
Short mounting bracket	2	16-0643
Screw, M4 x 16	4	24-7733
Crinkle washer, M4	4	24-2802
Spacer, plain, M4 x 5	4	24-4112
Spacer, female	2	14-1583
Spacer, male	2	14-1584
Mating plate	1	13-2000
Rivet, plastic	4	24-3211
Screw, M6 x 16	4	24-7995
Cup washer, M6	4	24-2809
Caged nut, M6	4	24-2240

35 Prepare the instrument as follows:

- (1) Disconnect the AC power cord at the rear panel.
- (2) Remove the two screws which secure the bezel to the rear panel; remove the bezel.
- (3) Remove the bottom cover by sliding it towards the rear of the instrument.
- (4) Remove the instrument's feet from the bottom cover and retain them for future use.
- (5) Replace the bottom cover. Replace and secure the bezel.

(6) Remove the four blind grommets from the sides of the instrument. This will reveal two threaded holes in each side frame.

36 Assemble the kit to the instrument as follows:

- (1) On each side of the instrument, secure a mounting bracket to the side frame, using two plain spacers, M4 screws and crinkle washers. Position the spacers between the mounting bracket and side frame.
- (2) Fit the cup washers to the M6 screws. Offer the instrument up to the rack in the left-hand position, and secure the brackets to the rack using the M6 screws and nuts.

Temperature Compensated Frequency Standard, 11-1713 (Option 04T)

37 The kit comprises:

Item	Qty	Racal-Dana Part Number
Plate assembly	1	11-1610
Oscillator PCB	1	19-1208
Crinkle washer, M3	3	24-2801
Screw, M3 x 6	3	24-7721

Installation

- 38
- (1) Disconnect the AC power cord at the rear panel.
 - (2) Remove the two screws which secure the bezel to the rear panel; remove the bezel.
 - (3) Remove the four blind grommets from the sides of the instrument.
 - (4) Remove the top cover by sliding it towards the rear of the instrument.
 - (5) Remove the frequency standard already fitted. Instructions are given in this chapter, according to type.
 - (6) Secure the PCB to the plate assembly, using an M3 screw and washer from the kit. The screw should be passed through the mounting hole in the board and screwed into the threaded spacer of the plate assembly. The component side of the board should be towards the plate assembly.
 - (7) Connect the PCB to the motherboard at PL14, with the plate assembly towards the rear panel of the instrument.
 - (8) Secure the plate assembly to the rear panel, using two M3 screws and washers. The screws pass through the holes adjacent to **FREQ. STD. ADJUST** aperture and screw into the plate assembly.

- (9) Replace the top cover. Replace the four blind grommets. Replace and secure the bezel.

Removal

- 39 (1) Remove the two screws adjacent to the **FREQ. STD. ADJUST** aperture in the rear panel.
- (2) Pull the PCB and plate assembly upwards until the board is disconnected from the motherboard.

Ovened Frequency Standards 11-1710 and 11-1711 (Options 04A and 04B)

- 40 The kit comprises:

Item	Qty	Racal-Dana Part Number
Oscillator assembly	1	9444 for 11-1710 9423 for 11-1711
Crinkle washer, M3	2	24-2801
Screw, M3 x 6	2	24-7721

Installation

- 41 (1) Disconnect the AC power cord at the rear panel.
- (2) Remove the two screws which secure the bezel to the rear panel; remove the bezel.
- (3) Remove the four blind grommets from the sides of the instrument.
- (4) Remove the top cover by sliding it towards the rear of the instrument.
- (5) Remove the frequency standard already fitted. Instructions are given in this chapter, according to type.
- (6) Connect the flying lead on the oscillator assembly to PL14 on the motherboard.
- (7) Secure the oscillator assembly to the rear panel of the instruments, using the M3 screws and washers. The screws pass through the holes adjacent to the **FREQ. STD. ADJUST** aperture and screw into the oscillator assembly.
- (8) Replace the top cover. Replace the blind grommets. Replace and secure the bezel.

Removal

- 42 (1) Remove the two screws adjacent to the **FREQ. STD. ADJUST** aperture in the rear panel.
- (2) Lift the oscillator assembly out of the chassis and disconnect the flying lead from the motherboard at PL14.

Reference Frequency Multiplier Option 11-1645 (Option 10)

- 43 The kit comprises:

Item	Qty	Racal-Dana Part Number
Frequency multiplier	1	19-1164
Crinkle washer, M3	2	24-2801
Screw, M3 x 6	2	24-7721

Installation

- 44 (1) Disconnect the AC power cord at the rear panel.
- (2) Remove the two screws which secure the bezel to the rear panel; remove the bezel.
- (3) Remove the four blind grommets from the sides of the instrument.
- (4) Remove the top cover by sliding it towards the rear of the instrument.
- (5) Remove the frequency standard if an ovened type is fitted.
- (6) Remove the shorting links between pins 5 and 6 and pins 8 and 9 on PL16.

NOTE: These links should be stored in a safe place. They must be replaced if Option 10 is removed from the instrument.

- (7) Connect the frequency multiplier PCB to the motherboard at PL16 and PL17, with the threaded spacers towards the right-hand side frame.
- (8) Secure the PCB to the side frame, using the M3 screws and washers.
- (9) Replace and secure the frequency standard if it was removed in (5).
- (10) Replace the top cover. Replace the blind grommets. Replace and secure the bezel.

Battery Pack Option 11-9009 (Option 07)

45 The kit comprises:

Item	Qty	Racal-Dana Part Number
PCB assembly	1	11-7051
Mounting bracket	1	11-1599
Battery pack	1	11-1723
Cover plate	1	13-2040
Crinkle washers, M3	2	24-2801
Screws, M3 x 6	2	24-7721
Crinkle washers, M4	2	24-2802
Screws, M4 x 8	2	24-7730
Plain washers, M4	6	24-2705
Spare fuse, 3A	1	24-0069
Cup Washer, nylon	4	24-2816
Screw, M4 x 10 C'sk	4	24-7543
Plain washer, M3	3	24-2703
Handles	2	15-0771
Screws, M4 x 12 Pan Head	4	24-7732
Insert	2	13-2060

NOTE: This option cannot be fitted to an instrument already fitted with the GPIB interface without first removing the GPIB interface.

Installation

- 46
- (1) Disconnect the AC power cord at the rear panel.
 - (2) Remove the two screws which secure the bezel to the rear panel; remove the bezel.
 - (3) Remove the four blind grommets from the sides of the instrument.
 - (4) Remove the top cover by sliding it towards the rear of the instrument.
 - (5) (a) Remove the blanking plate from the rear panel by pushing out the rivets from the inside of the instrument.

OR

- (b) Remove the GPIB assembly, if fitted, see Section 7 of the Maintenance Manual.
- (6) Hold the PCB assembly with the switches to the rear of the instrument and the PCB connector pointing downwards.
- (7) Carefully lower the assembly into the chassis, guiding the switches through the rear panel and connect the PCB to the motherboard at PL21, taking care that it mates correctly.

- (8) Position the cover plate over the switches protruding through the rear panel and secure using the M3 screws and washers.
- (9) Fit the mounting bracket to the side frame, using two M4 x 10 countersunk screws, cup washers and plain washers.
- (10) With the flying lead towards the rear of the instrument, carefully lower the battery pack into the instrument, ensuring that the lower left hand lug passes through the aperture in the heatsink/sidepanel. Also check that the upper right hand supporting lug rests on the mounting bracket.
- (11) Secure the battery pack to the left-hand side frame using two M4 x 10 countersunk screws, cup washers and plain washers. Secure the right-hand supporting lugs to the mounting bracket using M4 screws, plain and crinkle washers.
- (12) Connect the flying lead on the battery pack to the connector on the PCB assembly.
- (13) Replace the top cover. Replace the blind grommets. Replace and secure the bezel.
- (14) Fit the handles, using the M4 x 12 screws. Fit the self adhesive inserts.

Power Limiter Option 17-1103 (Option 11)

47 The kit comprises:

Item	Qty	Racal-Dana Part Number
Power Limiter	1	17-1103

Installation

48 (1) Remove the instrument top cover and the module stack as described in Section 7 of the Maintenance Manual.

NOTE: The coaxial and ribbon connectors do not have to be removed from the module stack. Carefully place the module stack on top of the GPIB board.

- (2) Remove the Sampler Module as described in Section 7 of the Maintenance Manual.
- (3) Loosen Channel C ring nut and retighten finger-tight only.
- (4) Connect the Power Limiter to the Sampler Bracket connector with the Limiter main label facing away from the bracket.
- (5) Connect the Sampler to the Power Limiter and secure the connector finger-tight only.
- (6) Refit the Sampler to the bracket with the retaining screws finger-tight only.

- (7) Tighten the SMA connector to 1 Nm using the SMA torque wrench. Fully tighten Channel C ring nut and tighten the Sampler Module securing screws.
- (8) Replace the complete assembly in the instrument. Reconnect PL32 and 36 to the Sampler Module.
- (9) Reconnect SK15 to PL15 on the motherboard.
- (10) Replace the ring nut on the Input C connector.
- (11) Replace the Module Stack ensuring the coaxial cables are located correctly.
- (12) Refit the top cover and rear panel bezel. Refit the bungs or the handles if previously fitted.
- (13) Fit the option label to the serial number label on the instrument.

SECTION 4

OPERATING INSTRUCTIONS

INTRODUCTION

- The instrument should be prepared for use in accordance with the instructions given in Section 3. If the instrument is being used for the first time, or at a new location, pay particular attention to the setting of the AC voltage selector and the fuse rating.

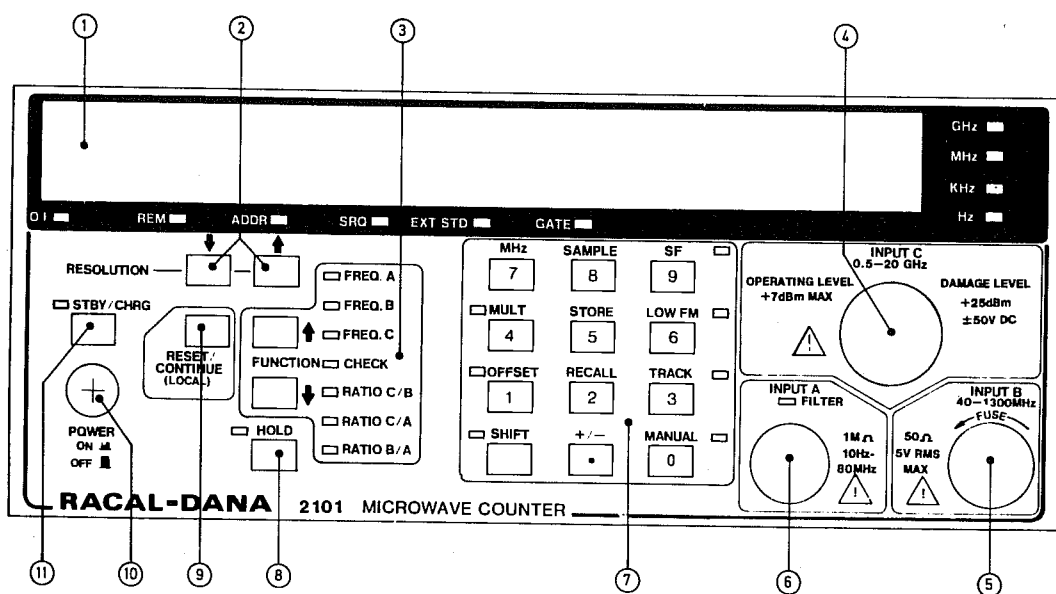

DESCRIPTION OF CONTROLS, INDICATORS AND CONNECTORS

Front Panel Items

2

Reference	Item	Description
①	Display	A 13-digit LED display, used to display: (1) The result of a measurement. (2) A number awaiting entry into an internal store. (3) A number recalled from an internal store. (4) Error indication.

Reference	Item	Description
	O/F Indicator	Lights when the measurement result has overflowed the most significant digit of the display.
	REM Indicator	Lights when the instrument is operating under remote control.
	ADDR Indicator	Lights when the instrument is acting as a listener or a talker.
	SRQ Indicator	Lights when the instrument generates a service request.
	EXT STD Indicator	Lights when the instrument is operating from an external frequency standard.
	GATE Indicator	Lights while a measurement cycle is in progress.
	Display Units Indicators	Four indicators show the scale of the display in terms of frequency.
②	Resolution Control Keys	Used to step the display resolution up or down as shown by the arrows.
③	Function Selector	The primary measurement functions can be selected in turn using the arrowed FUNCTION keys. The function selection 'wraps round' at both ends.
④	INPUT C Connector	Precision N female type connector for inputs from 500MHz to 20GHz.
⑤	INPUT B Connector	BNC female fused connector for inputs from 40 MHz to 1.3 GHz.
⑥	INPUT A Connector	BNC female connector for inputs from 10 Hz to 80 MHz.

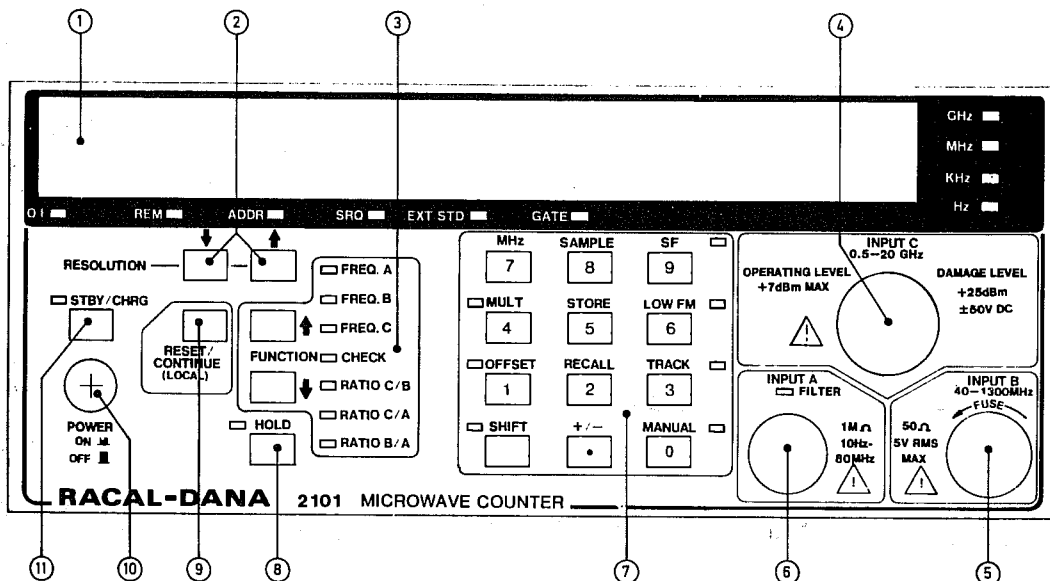

Reference	Item	Description
⑦	Numeric Keypad	Used to enter numbers into, and recall numbers from, the instrument's internal stores. Also used to enable and disable the math functions, the special functions, and to select alternate FREQ.C acquisition modes.
⑧	HOLD Key and Indicator	Successive operations put the instrument into and out of the Hold (single-shot measurement) mode. The indicator lights when the instrument is in the Hold mode. Readings are triggered using the RESET key.
⑨	RESET/CONTINUE (LOCAL) Key	This key has three functions: RESET Clears the display and triggers a new measurement cycle when the instrument is in the measurement mode. CONTINUE Returns the instrument to the measurement mode and triggers a measurement cycle. It can also be used to clear the OP Er indication. LOCAL Returns the instrument to local control from remote GPIB control provided local lockout is not set.

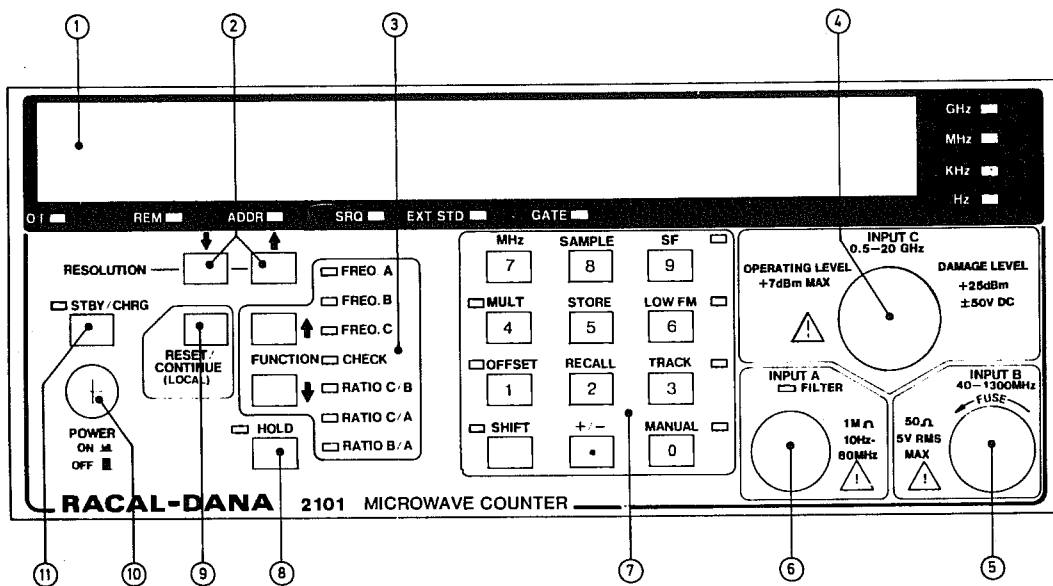

Reference	Item	Description
⑩	POWER Switch	Controls the AC or DC power to the instrument.
⑪	STBY/CHRG Key and Indicator	Successive operations switch the instrument into and out of the standby state. The indicator lights when the instrument is in the standby state. If the Battery Pack option is installed the indicator flashes when the battery approaches the discharged state. the battery is charged at the full rate when the instrument is in standby and external power is applied.

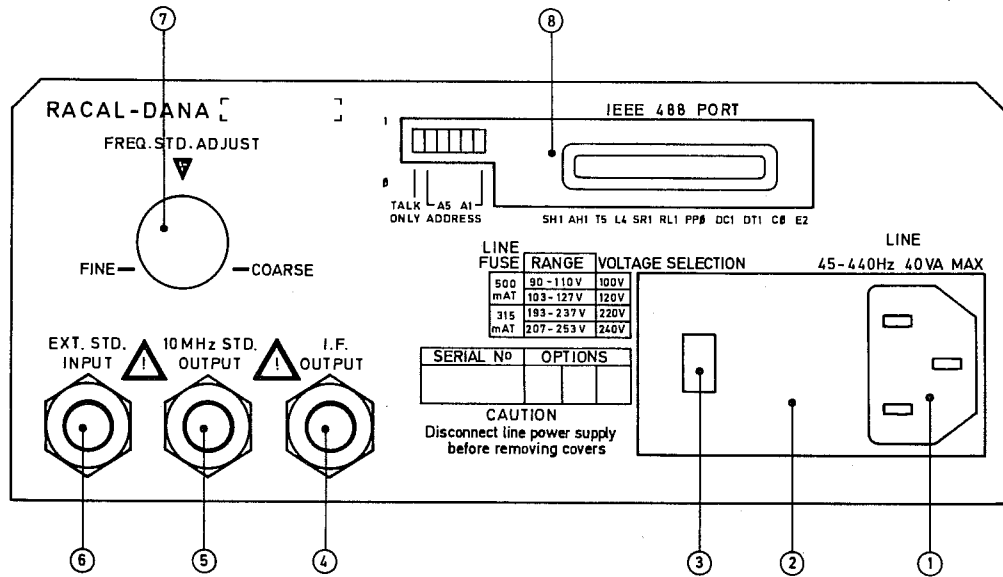

Rear Panel Items

3

Reference	Item	Description
①	AC Power Input Plug (See NOTE)	A standard connector for the AC power supply. A RFI filter is incorporated.
②	Line Fuse (See NOTE)	A 5mm x 20mm, surge-resistant, glass cartridges fuse, located under a hinged cover next to the AC supply plug. The required fuse ratings for different line voltage ranges are shown on the panel and in Section 3 of this manual.
③	Line Voltage Selector (See NOTE)	Voltage selection is changed by repositioning a small drum under a hinged cover next to the AC supply plug.

NOTE: Items 1, 2 and 3 are all incorporated in one Schaffner connector unit.

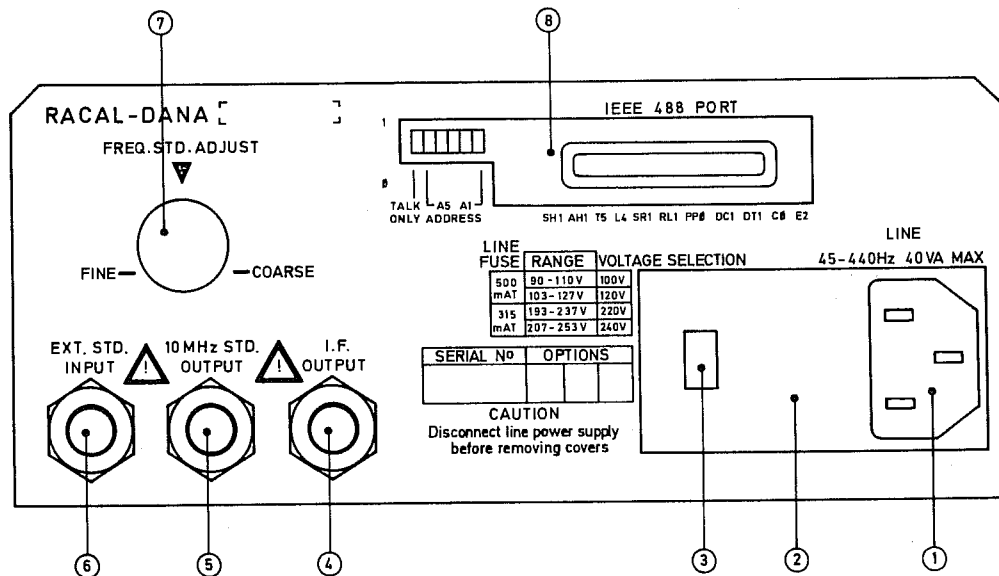

Reference	Item	Description
④	I.F. OUTPUT	A BNC female connector, providing an I.F. output when making measurements on INPUT C. Output is continuously available in manual operation. In automatic operation the output is available during the gate time.
⑤	10 MHz STD OUTPUT	A BNC female connector, providing a 10 MHz signal locked to the frequency standard in use.
⑥	EXT. STD. INPUT	A BNC female connector for connecting an external frequency standard input. The frequency required is 10MHz unless the reference frequency multiplier option is fitted. With this option, frequencies of 1 MHz, 2 MHz, 5 MHz and 10 MHz may be used.

Reference	Item	Description
⑦	FREQ. STD. ADJUST	This aperture provides access to allow adjustment of the internal frequency standard.
⑧	<p data-bbox="517 532 697 562">GPIB Interface</p> <p data-bbox="517 595 689 655">GPIB Address Switches</p> <p data-bbox="517 914 712 944">GPIB Connector</p>	<p data-bbox="822 599 1354 724">Switches A1 to A5 define the listen and talk addresses for GPIB operation in the addressed mode. The talk-only switch must be in the '0' position.</p> <p data-bbox="822 756 1332 881">With the talk-only switch in the '1' position the instrument is set to the talk-only condition. The positions of switches A1 to A5 are then irrelevant.</p> <p data-bbox="822 914 1351 1080">An IEEE-488-1978 std. connector used to connect the instrument to the GPIB. An adaptor, Racal-Dana part number 23-3254, to convert the connector to the IEC 625-1 standard is available as an accessory.</p>

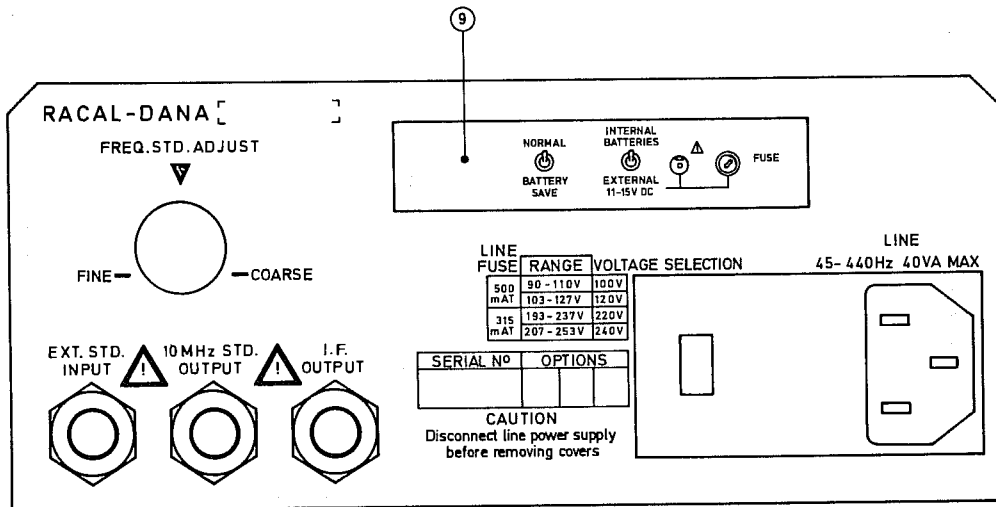

Reference	Item	Description
9	Battery-pack option	
	External DC Input	Permits the instrument power to be derived from an external fused DC supply.
	NORMAL/BATTERY SAVE Switch	Used to select the Battery-Save function.
	INTERNAL/EXTERNAL DC Supply Switch	Used to select operation from the internal battery or an external DC supply.
	DC Supply Fuse	A 0.25 x 1.25 inch glass cartridge fuse of the surge-resistant type. The required rating is 3 AT.

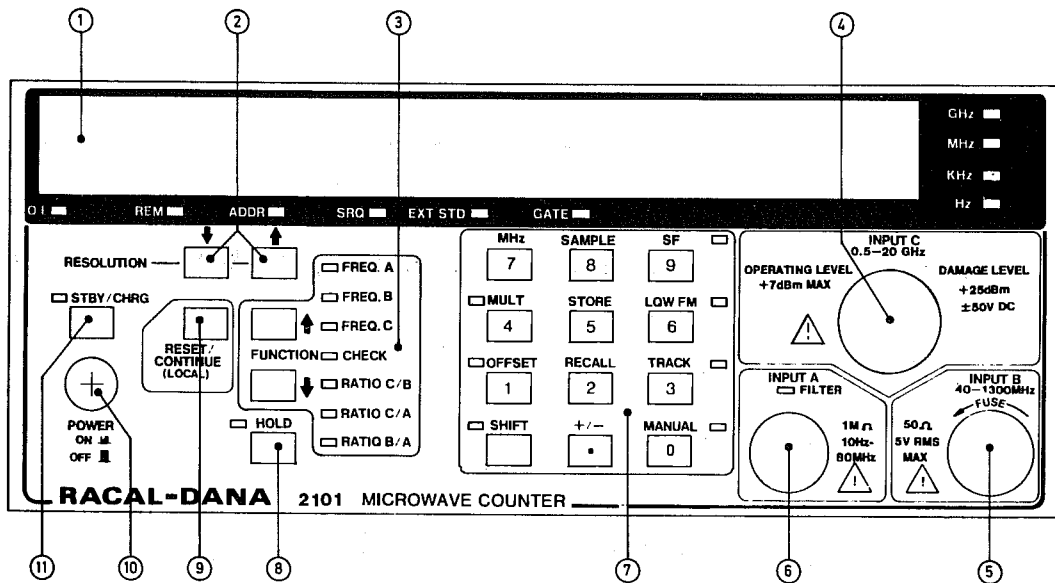

FREQUENCY MEASUREMENT - INPUT A

- 4 (1) Press the POWER switch (10) to switch on.
- (2) Select FREQ A using the FUNCTION keys (3).
- (3) Select the required display resolution, using the RESOLUTION keys (2).

NOTE: Gate time is related to the resolution selected.

- (4) If a frequency below 50 kHz is to be measured in the presence of HF noise, select the low-pass input filter by selecting special function SF 11 (see 'SPECIAL FUNCTIONS' in this Section of the Manual). Ensure that the FILTER indicator lights.

CAUTION: SIGNAL LEVEL

ENSURE THAT THE INPUT SIGNAL LEVEL DOES NOT EXCEED THE DAMAGE LEVELS SPECIFIED IN SECTION 1 OF THIS MANUAL.

- (5) Connect the signal to be measured to INPUT A (6).
- (6) If HOLD mode operation is required, select HOLD (8). To take a measurement, press the RESET key (9). Check that the GATE indicator lights during the measurement period. To return to the continuous measurement mode, press the HOLD key (8) again.

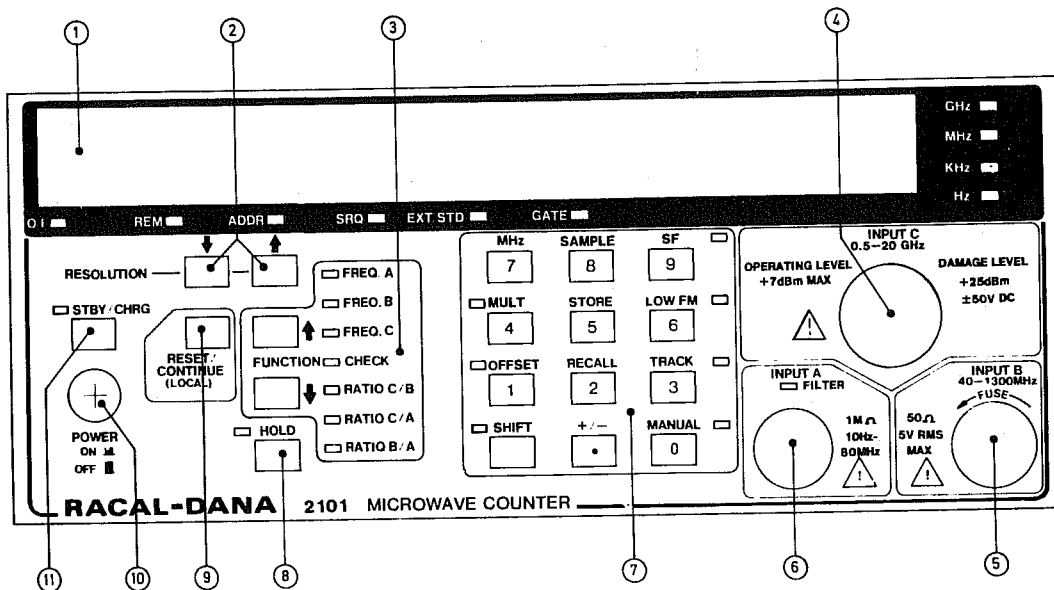

FREQUENCY MEASUREMENT - INPUT B

- 5
- (1) Press the POWER switch (10) to switch on.
 - (2) Select FREQ B using the FUNCTION keys (3).
 - (3) Select the required display resolution, using the RESOLUTION keys (2).

Note: Gate time is related to the resolution selected.

CAUTION: SIGNAL LEVEL

ENSURE THAT THE INPUT SIGNAL LEVEL DOES NOT EXCEED THE DAMAGE LEVELS SPECIFIED IN SECTION 1 OF THIS MANUAL.

NOTE: INPUT B is fused, see SECTION 1 of this manual.

- (4) Connect the signal to be measured to INPUT B (5).
- (5) If HOLD mode operation is required, select HOLD (8). To take a measurement, press the RESET key (9). Check that the GATE indicator lights during the measurement period. To return to the continuous measurement mode, press the HOLD key (8) again.

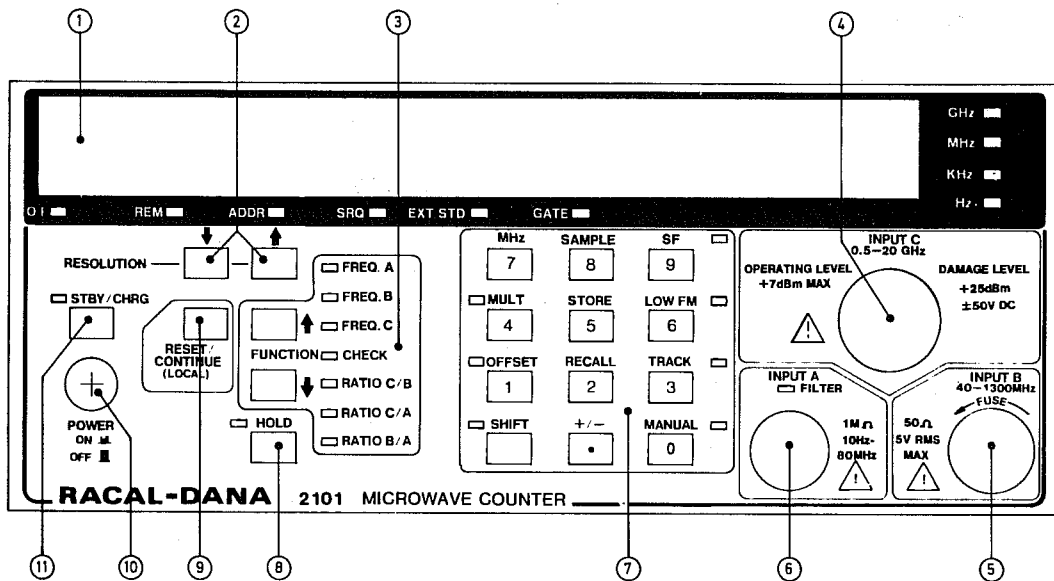

FREQUENCY MEASUREMENT - INPUT C

Normal Automatic Mode

- 6
- (1) Press the POWER switch (10) to switch on.
 - (2) Select FREQ C using the FUNCTION keys (3)
 - (3) Select the required display resolution, using the RESOLUTION keys (2).

NOTE: Gate time is related to the resolution selected and the input frequency.

CAUTION: SIGNAL LEVEL

ENSURE THAT THE INPUT SIGNAL LEVEL DOES NOT EXCEED THE DAMAGE LEVELS SPECIFIED IN SECTION 1 OF THIS MANUAL.

- (4) Connect the signal to be measured to INPUT C (4).
- (5) If HOLD mode operation is required, select HOLD (8). To take a measurement, press the RESET key (9). Check that the GATE indicator lights during the measurement period. To return to the continuous measurement mode, press the HOLD key (8) again.

Manual Mode

7 In this mode the measured frequency, or a keyboard entered frequency value, is entered into the MANUAL Store, then MANUAL Mode is then selected.

8 (1) To store a center frequency (the example shows 19 GHz), press:



(2) To store the frequency shown in the display press:



(3) If Manual Mode was previously selected the new entered value of frequency is used immediately, otherwise, to enable Manual Mode press:

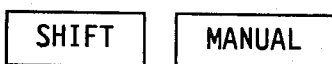

Further Functions in FREQ C (Automatic Mode Only)

9 In FREQ C, normal AUTOMATIC Mode, two more (shifted) functions are available, these are LOW FM and TRACK.

NOTE 1:

These functions are not available in MANUAL Mode.

NOTE 2:

LOW FM and TRACK functions are mutually exclusive; only one of the functions being available at a time.

10 Selection of one function (e.g. TRACK), whilst the other function (LOW FM) is in use, will switch off the previously used function (LOW FM). Switching off the last used function (TRACK) will then return the instrument to AUTOMATIC Mode, NOT the previously used function.

Set LOW FM (FREQ C)

11 This function utilizes longer gate times to accommodate signals with low modulation rates.

12 To use this function proceed as follows:

(1) Proceed as described in 'FREQUENCY MEASUREMENT - INPUT C'.

(2) Press:



The LOW FM indicator lights.

(3) To exit, press:



The LOW FM indicator goes out.

Set TRACK (FREQ C)

13 This function enables the instrument to measure and display swept frequencies.

14 To use this function proceed as follows:

(1) Proceed as described in 'FREQUENCY MEASUREMENT - INPUT C'.

(2) Press:



The TRACK indicator lights.

(3) To exit, press:



The TRACK indicator goes out.

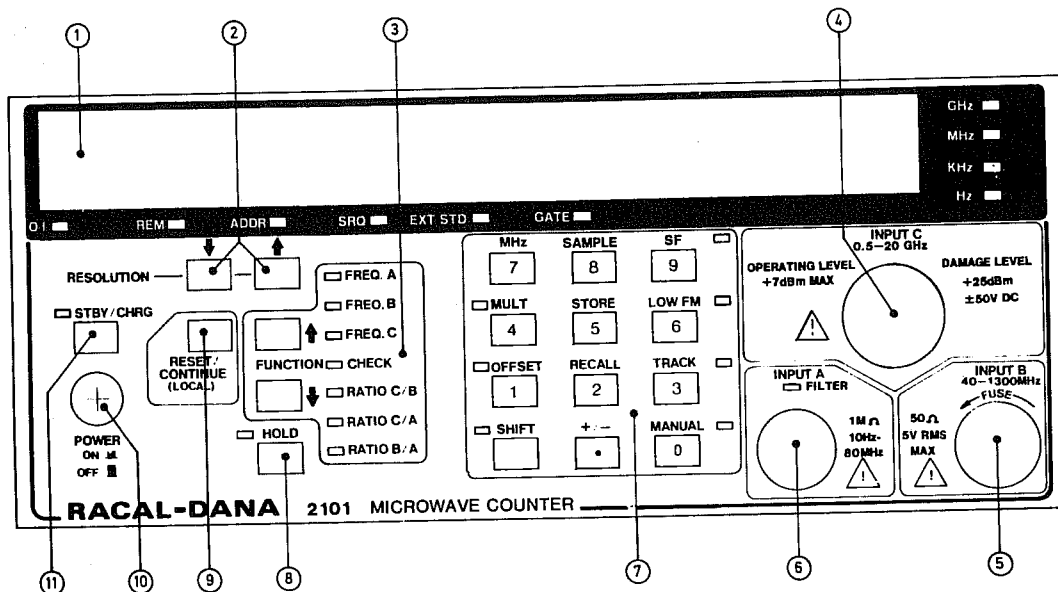

RATIO MEASUREMENTS C/B, C/A AND B/A

- 15 These three Ratio Modes use a 'software' ratio method, whereby the denominator is sampled first, followed by the numerator. The microprocessor in the instrument then computes the ratio and displays the result.
- 16 For certain specific applications a 'hardware' version of RATIO B/A is available by enabling Special Function 91. This allows 'real time' ratio measurements to be made.
- 17 (1) Press the POWER switch (10) to switch on.
- (2) Select the relevant RATIO function using the FUNCTION keys (3).
- (3) Select the required display resolution, using the RESOLUTION keys (2).
- (4) If INPUT A is being used for a frequency below 50 kHz in the presence of HF noise, select the Low Pass Input Filter (SF 11).

CAUTION: SIGNAL LEVEL

ENSURE THAT THE INPUT SIGNAL LEVEL DOES NOT EXCEED THE DAMAGE LEVELS SPECIFIED IN SECTION 1 OF THIS MANUAL.

NOTE: INPUT B is fused, see SECTION 1 of this manual.

- (5) If hold mode operation is required, select HOLD (8). To take a measurement, press the RESET key (9). Check that the GATE indicator lights during the measurement period. To return to the continuous measurement mode, press the HOLD key (8) again.

SAMPLE RATE

- 18 On initial switch-on the instrument will sample signals at the highest rate (time interval between readings is \emptyset). However, the user can slow the sample rate down using the SAMPLE function. This sets the time interval between readings (hold time) and hence controls the sample rate.

Setting and Using the Sample Rate

- 19 To alter the sample rate, proceed as follows:

- (1) Enter the display time required (e.g. for 100 mSec enter 0.1), using the keypad (7).
(2) Press:



This enters the reading hold time into the SAMPLE register and is used immediately.

Displaying the Sample Rate

- 20 To display the reading hold time in use, press:

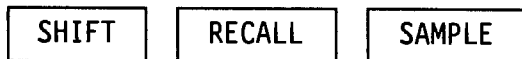

The sample rate is shown in the display.

- 21 To return to measurement mode, press the RESET key (9).

MULT FUNCTION

- 22 This function is used to display the input signal multiplied by the number held in the MULT (Multiply) register. This function can be used, for instance, to display the true frequency reading of a signal source that has been divided or multiplied before being sampled by the instrument.

Setting the Multiplier

- 23 To store a multiplier for later use, proceed as follows:

- (1) Enter the number of the multiplier required, using the keypad (7).
(2) Press:



This enters the multiplier into the MULT register for future use.

Enabling the Multiplier

- 24 To enable the stored multiplier, press:



The MULT indicator lights. The instrument displays the input signal scaled by the value held in the MULT store.

- 25 To exit this function, press:



The MULT indicator goes out.

Displaying the Multiplier

- 26 If necessary the stored multiplier can be displayed by pressing:

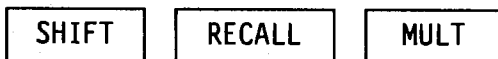

The multiplier is shown in the display.

- 27 To return to measurement mode, press the RESET key **9**.

OFFSET FUNCTION

- 28 This function can be used to add or subtract a value to the measured frequency. It is also used to subtract the displayed frequency (nulling) to view drift or offset. For example: measuring the IF of a radio receiver, after entering the receiver local oscillator frequency as a positive offset, enables the true input frequency to be displayed.

Setting the Offset

- 29 If enabled, the offset frequency entered is normally subtracted from the measured signal frequency. The sign of the offset can be altered at any point during number entry by pressing:



To store the offset frequency, proceed as follows:

- (1) To enter an offset frequency (this example shows 10.5 MHz), press:



This enters the offset frequency into the OFFSET register.

- (2) To enter the displayed frequency as an offset, press:



Enabling the Offset

- 30 To enable the stored offset, press:



The OFFSET indicator lights. The instrument displays the input minus the value held in the OFFSET register.

- 31 To exit this function, press:



The OFFSET indicator goes out.

Displaying the Offset

- 32 To display the stored offset, press:

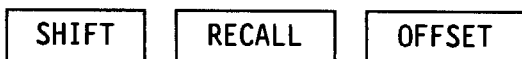

The offset is shown in the display.

- 33 To return to measurement mode, press the RESET key (9).

SMOOTH FUNCTION (SPECIAL FUNCTION 21)

- 34 This is Special Function 21 (see 'SPECIAL FUNCTIONS' in this Section of the Manual). Selecting SMOOTH enables the instrument to take a 'running average' of the input frequency and display those digits that are stable.

DISPLAY RESOLUTION

- 35 Resolution, in this context, refers to the number of zeros displayed after pressing RESET with no signal applied at an input. The resolution can be set to display from three to 10 decimal places. A 10% overrange of the display is permitted without a change of range. Because of this, an additional digit with a value of 1 is allowed at the more significant end of the display when measurements are made. With a resolution of 10 selected, the presence of this extra digit may result in the overflow (O/F) indicator being lit (FREQ C only, resolution of 0.1 Hz).
- 36 The resolution is changed using the arrowed resolution keys. To step up from nine to ten digits, the step-up key must be held for about two seconds.
- 37 With hardware RATIO B/A (SF 91) selected, no more than seven digits (plus a possible overrange) are displayed, regardless of the resolution selected.

GATE TIME

- 38 For INPUTs A and B, Gate Time is related to the resolution selected, as shown in TABLE 4.1a.

TABLE 4.1a

Gate Times for FREQUENCIES A and B

Number of digits in FREQ A, FREQ B & CHECK	Gate Time	Resolution Number
10	20 s	10
9	1 s	9
8	100 ms	8
7	10 ms	7
6	1 ms	6
5	1 ms	5
4	1 ms	4
3	1 ms	3

- 39 For INPUT C, Gate Time is related to both the resolution selected and the input frequency, as shown in TABLE 4.1b.

TABLE 4.1b

Gate Times for FREQUENCY C

Frequency GHz	Resolution			
	1 Hz	10 Hz	100 Hz	1 kHz
0.5 - 1.0	100 ms	10 ms	1 ms	1 ms
1.0 - 4.0	200 ms	20 ms	2 ms	1 ms
4.0 - 8.0	400 ms	40 ms	4 ms	1 ms
8.0 - 12.0	600 ms	60 ms	6 ms	1 ms
12.0 - 16.0	800 ms	80 ms	8 ms	1 ms
16.0 - 20.0	1 s	100 ms	10 ms	1 ms

SPECIAL FUNCTIONS

- 40 The special functions provided for use by the operator are listed in TABLE 4.2 Major Special Functions, and TABLE 4.3 Minor Special Functions. The major functions are those most commonly used by the operator. Each special function is defined by a two-digit number.

TABLE 4.2

Major Special Functions

Function	Code
Deselects Channel filter	10
Selects Channel A filter	11
Cancels Smooth function	20
Selects Smooth function (See NOTE 1)	21
Leading (function) letters in O/P string	80
No leading (function) letters in O/P string	81
Cancels group 90 special functions	90
Enables hardware ratio B/A	91

Setting the Special Function Register

- 41 When a special function is to be used, its number must first be entered into the register. To do this press:



Where N N is the special function number to be entered. The digits enter the display as the keys are pressed. The instrument returns to the measurement mode automatically once the number is stored.

- 42 When a number is stored, it overwrites the previously stored number in the same decade. To remove a number from the register, another number must be stored.
- 43 The numbers in the register are retained while the instrument is switched to the standby mode.

Enabling and Disabling the Special Functions

- 44 The group of special functions whose numbers are entered in the special function register are enabled and disabled by pressing:



The SF indicator is lit when special functions are enabled.

TABLE 4.3

Minor Special Functions

Function	Code
Cancels all group 30 special functions	30
Displays Local Oscillator Value (See NOTE 2)	31
Displays Intermediate Frequency (See NOTE 3)	32
Displays Harmonic Number as an integer (See NOTE 3)	33
Displays Harmonic Number with fractional part (See NOTE 3)	34
Displays IF Detector Status (See NOTES 3 & 4)	35
Displays IF Filter Status (See NOTES 3 & 4)	36
Displays LO Detector Line Status	37
Cancels all group 40 special functions	40
Allows setting of LO & Harmonic Number (See NOTES 3 & 5)	41
Switches LO Off under all conditions	42
Disables IF output under all conditions	43
Cancels all group 50 special functions	50
Ignore IF level detector	51
Cancels all group 70 special functions	70
Initiates front panel display checks	71
	72
These codes are reserved for diagnostic purposes and are described in the Maintenance Manual (See NOTE 6)	73
	74
	75

NOTE 1: This function does not operate on diagnostic special functions.

NOTE 2: This function only operates during INPUT C measurements and displays the value of Local Oscillator used to make a measurement.

NOTE 3: Operates under same conditions as Special Function 31.

NOTE 4: '0' displayed = Facility Not Present.
 '1' displayed = Facility Present.
 (Special Function 41 must also be active).

NOTE 5: MANUAL LED is on, LO and Harmonic Number (HN) register both active. To access LO use TRACK key, to access HN use LOW FM key.

NOTE 6: Special Functions 71 to 75 can be entered into the special functions register at any time. They are active only when the instrument is in Check Mode.

- 45 The default state corresponds to the default state of the special function register, i.e., with special functions 10, 20, 30, 40, 50, 60, 70, 80 and 90 enabled.

NOTE: A special function entered in the register while the special functions are enabled will be enabled immediately.

To recall Special Function Register

- 46 One special function from each decade is entered into a special function register. Only the second digit is stored; the decade is indicated by the position of the digit in the register. The default state is with 0 entered in each position.
- 47 To display the contents of the register press:



A typical display is shown in Fig. 4.1.

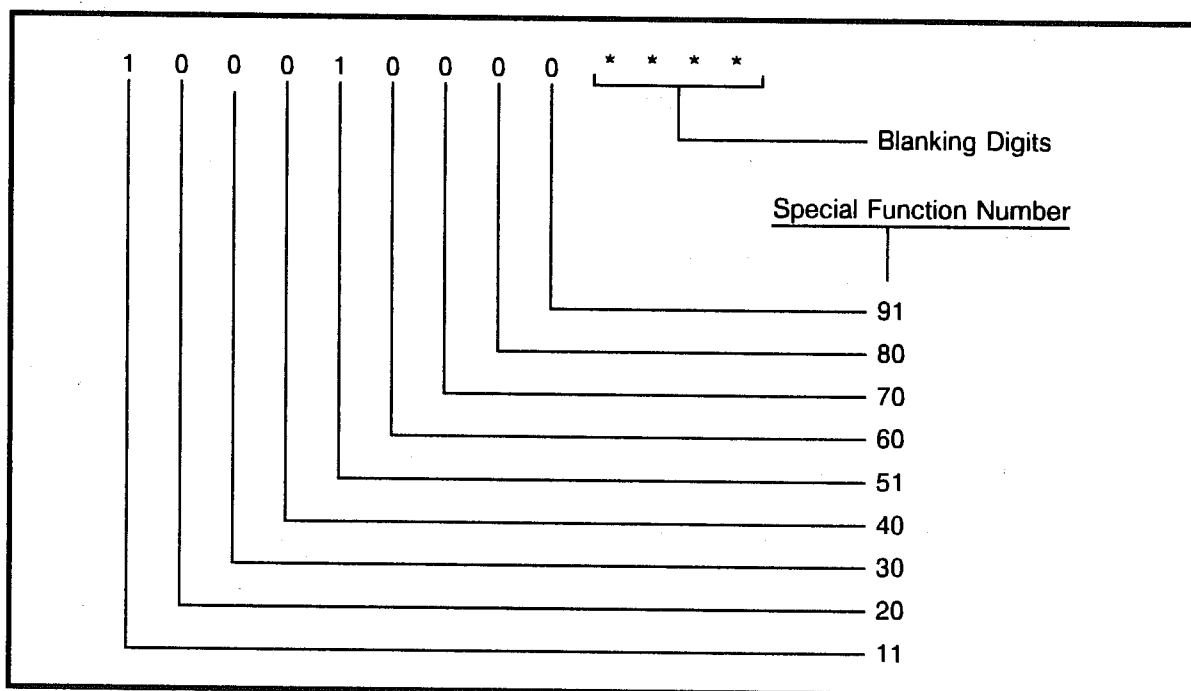

Fig. 4.1 Special Function Register Display

ERROR CODES

- 48 The instrument is able to detect a number of error states, which are indicated on the display. The meanings of the error codes are shown in Table 4.4.

TABLE 4.4

Error Codes

Display	Error
Op Er	Operator error caused by 'illegal' entries or attempt to enter a value out of range.
Er 02	Measurement result too large, or small, for display.
Er 03	Overflow of internal counters.
Er 50	Incorrect result obtained when in check mode.
Er 51	Local oscillator out of lock.
Er 60	EPROM paging failure.
Er 61	RAM failure.

Clearing the Error Codes

- 49 Error codes are cleared as follows:

- (1) Op Er, Er 02 and Er 03: Press RESET/CONTINUE (Local) key and select another measurement function.
- (2) Er 50, Er 51, Er 60 and Er 61: These are equipment failure errors, switch off instrument and return it for repair.

USING THE BATTERY PACK OPTION

WARNING: LETHAL VOLTAGE

IF MEASUREMENTS ARE MADE ON SIGNAL SOURCES AT VOLTAGES GREATER THAN 50 V DC WITH THE INSTRUMENT POWERED FROM THE INTERNAL BATTERY OR AN EXTERNAL DC SUPPLY, THE GROUND CONNECTOR OF THE AC POWER SUPPLY INPUT ON THE INSTRUMENT MUST BE CONNECTED TO GROUND.

Power Supply Changeover

- 50 When the battery pack option is installed, the instrument can be powered from the internal battery, an external DC supply of 11 V to 16 V, or an external AC supply. If the instrument is operating from either the external DC supply or the battery, it will automatically change to operation from the AC supply when this is connected. To prevent accidental battery discharge, the battery will not take over from either the AC or external DC supply if that supply fails. An external DC supply will not take over from the AC supply if the AC supply fails.

Battery-Low Indication

- 51 When the instrument is working from the internal battery, or from an external DC supply, the STBY/CHRG indicator will start to flash as the supply voltage approaches the minimum permissible level. This occurs regardless of whether the instrument is in the standby mode or not. When operating from the battery, the instrument can be used in the measurement mode for approximately 10 minutes after the indicator commences flashing.
- 52 When the voltage of the battery or external DC supply reaches the minimum permissible level, the instrument shuts down completely.

Operating Instructions

- 53 Instructions for preparing the instrument to make measurements are given in the following paragraphs. No other change in the operating procedure is required.

Operating From the Battery

- 54 (1) Set the INT/EXT switch on the rear panel to INT.
- (2) Set the BATTERY SAVE/NORMAL switch to NORMAL.
- (3) Switch the instrument on.
- (4) Check that the instrument goes through the normal switch-on sequence. If the STBY indicator is flashing, or if there is no display, charge the battery.
- 55 It is recommended that the Battery-Save facility should be used whenever possible. To select this set the BATTERY SAVE/NORMAL switch to BATTERY SAVE. The instrument will remain in the measurement mode for a predetermined period and will then switch to

standby. It can be returned to the measurement mode for the same period by pressing the STBY/CHRG key.

Operation From an External DC Supply

- 56 (1) Ensure that the instrument is switched off.
- (2) Connect an 11 to 16 Volts DC supply to the DC power-input plug on the rear panel. The mating connector is a 2.1 mm coaxial socket.

CAUTION: SUPPLY POLARITY

THE POSITIVE SIDE OF THE SUPPLY MUST BE CONNECTED TO THE CENTER CONDUCTOR. EVEN THOUGH THE EXT. DC INPUT OF THE INSTRUMENT IS FUSE PROTECTED, IT IS STILL VITAL THAT THE EXTERNAL SUPPLY IS FUSED USING A 3 AMP SLOW-BLOW FUSE, SINCE THE INPUT IS NOT FLOATING.

- (3) Set the INT/EXT switch on the rear panel to EXT.
- (4) Switch the instrument on. Check that the instrument goes through the normal switch-on sequence.
- 57 If the external DC supply is interrupted the instrument will not necessarily power-up again when the supply voltage is restored. In this event, switch off and then on again using the front panel POWER switch.

Battery Charging

- 58 The battery is trickle-charged whenever the instrument is operated from an AC supply and the internal/external switch is at INTERNAL BATTERIES. To charge the battery at the full rate, connect the instrument to an external AC supply, switch on and select the standby mode.

SECTION 5

OPERATION VIA THE GPIB

INTRODUCTION

- 1 The instrument must be prepared for use in accordance with the instructions given in Section 3. If the instrument is being used for the first time, or at a new location, pay particular attention to the setting of the AC line voltage selector.

GPIB OPERATING MODES

- 2 The instrument can be operated via the GPIB in either the addressed mode or the talk-only mode.

TALK ONLY MODE

- 3 The talk-only mode may be used in systems which do not include a controller. Such a system permits remote reading of the instrument's measurement data, but the instrument is operated by means of the front panel controls as described in Section 4.
- 4 The rate at which measurements are made is determined by the instrument. The output buffer is updated at the end of each measurement cycle, overwriting the previous measurement data if this has not been transferred to the listener.
- 5 The transfer of data from the instrument to the listener is triggered by the listener. The instrument's output buffer is cleared when the data transfer is complete. Problems arising from the differences between the measurement rate and data transfer trigger rate are resolved according to the following protocol:
 - (1) If data transfer is in progress at the end of a measurement cycle, the updating of the output buffer is delayed. The data transferred will relate to the previous measurement cycle.
 - (2) If the data transfer trigger occurs during a measurement cycle and the output buffer is empty, data transfer will be delayed until the buffer is updated. The data transferred will then relate to the latest measurement cycle.
 - (3) If a measurement cycle is completed before the results of the previous cycle have been transferred to the listener, the buffer will be updated. The data for the previous cycle will be overwritten and lost.
- 6 The rate at which measurements are made can be controlled in the following ways:
 - (1) The gate time of the instrument (duration of the measurement cycle) can be controlled by choosing an appropriate display resolution.

- (2) The instrument can be operated in the HOLD mode. Single measurement cycles can be triggered, when required, by means of the RESET/CONTINUE (Local) key.
 - (3) The display hold time can be set by entering a value, in seconds, into the sample store from the front panel.
- 7 The format of the data output is described in TABLE 5.1.

ADDRESSED MODE

- 8 In addressed mode operation, all the instruments functions, except power ON/OFF and the STANDBY/CHARGING facility, can be controlled by means of device-dependent commands, sent via the bus, when the instrument is addressed to listen.
- 9 The measurements made, and data regarding the instrument's status, can be read via the bus when the instrument is addressed to talk.

DATA OUTPUT FORMAT - NORMAL

- 10 The same output message format is used for the transmission of measured values and numbers recalled from the instrument's internal stores. The message consists of a string of 21 ASCII characters for each value transmitted. These are to be interpreted as shown in TABLE 5.1. The units should be assumed to be Hz, seconds, or a ratio, depending upon the commands previously given to the instrument.

DATA OUTPUT FORMAT - DUMP MODES

- 11 Dump mode output format is in the same output message format as normal data outputs. Display resolution is decreased thus decreasing computing and output time to allow for faster sample rates. Resolution of the readings is limited in the following ways:
- (1) **FREQ.C** readings restricted to 10 kHz resolution.
 - (2) **FREQ. A** and **FREQ. B** readings restricted to four digits resolution.
- 12 Certain other modes are forced in Dump mode, see TABLE 5.11d. Refer to TABLE 5.3 and 5.4 for Dump mode byte functions.

TABLE 5.1
Output Message Format

Byte No	Interpretation	Permitted ASCII Characters
1	Function Letter	See TABLE 5.2
2	Function Letter	See TABLE 5.2
3	Space	Missing if SF81 is active
4	Sign of measurement	+ or -
5	Most Significant Digit	0 to 9 or .
6	Digit	0 to 9 or .
7	Digit	0 to 9 or .
8	Digit	0 to 9 or .
9	Digit	0 to 9 or .
10	Digit	0 to 9 or .
11	Digit	0 to 9 or .
12	Digit	0 to 9 or .
13	Digit	0 to 9 or .
14	Digit	0 to 9 or .
15	Digit	0 to 9 or .
16	Digit	0 to 9 or .
17	Least Significant Digit	0 to 9 or .
18	Exponent Indicator	E
19	Sign of exponent	+ or -
20	More Significant Digit	0 to 9
21	Least Significant Digit	0 to 9

NOTE 1:

Bytes 5 to 17 will always include 13 digits and a decimal point. Zeros will be added, where necessary, in the more significant digit positions.

NOTE 2:

The exponent indicated by bytes 20 and 21 will always be a multiple of three.

TABLE 5.2**Function Letters**

Function	Function Letters
Frequency A	FA
Frequency B	FB
Frequency C	FC
Check	CK
Ratio C/B	CB
Ratio C/A	CA
Ratio B/A	BA
Recalled Data	Function Letters
Resolution	RS
Manual Store	MN
Offset Store	OS
Mult. Store	MU
Sample Rate Store	SA
Harmonic Number	HN
Local Oscillator Frequency	LO

NOTE: Bytes 1, 2 and 3 are not sent when special function 81 is active.

TABLE 5.3**Frequency C Dump**

Byte	Character	Function
1	0 to 9	GHz × 10
2	0 to 9	GHz
3	0 to 9	MHz × 100
4	0 to 9	MHz × 10
5	0 to 9	MHz
6	0 to 9	kHz × 100
7	0 to 9	kHz × 10
		Most significant digit

TABLE 5.4**Frequency A and B Dump**

Byte	Character	Function
1	0 to 9	Most significant digit (see NOTE)
2	0 to 9	Digit
3	0 to 9	Digit
4	0 to 9	Digit
5	0 to 9	Least significant digit
6	0 to 9	Exponent
7	0 to 9	Exponent Value, most significant digit
8	0 to 9	Exponent value, least significant digit

NOTE:

Implied decimal point position is before Byte 1.

SERVICE REQUEST

- 13 The instrument can be set, by means of device-dependent commands, to generate the service request message (SRQ) when:
- (1) A response message is ready.
 - (2) A 488.2 defined error occurs.
 - (3) A device defined error occurs.
 - (4) A change of frequency standard occurs.
 - (5) A user request for local control occurs.
- 14 The generation of the SRQ may also be inhibited. Generation of all SRQs is disabled when the instrument is first switched on.

STATUS BYTE

- 15 The format of the status byte, generated in response to a serial poll, is given in TABLE 5.6.

SETTING THE ENABLE REGISTERS

- 16 The Enable Registers to be set up are as follows:
- (1) Service Request Enable Register - set using *SRE.
 - (2) Standard Event Status Enable Register - set using *ESE.
 - (3) Device Defined Event Status Enable Register - set using ESE.
- 17 Each bit in an enable register set to logic '1' enables the equivalent bit in its associated service register, see Table 5.5 for Associated Registers.

TABLE 5.5

Associated Registers

Enable Register	Service Register
Service Request Enable Register	Status Byte Register
Standard Event Status Enable Register	Standard Event Status Register
Device Defined Event Status Enable Register	Device Defined Event Status Register

- 18 The enable registers are set up by entering the register enable codes in NR1 format. NR1 format comprises decimal numbers in the range 0 to 255 representing the binary codes entered into the enable registers. See TABLE 5.6 to TABLE 5.8 for register contents.
- 19 The following example illustrates a register bit setting code and the NR1 format entry.
- 20 Example:
- | | |
|--|-----------------|
| DIO Line Number: | 8 7 6 5 4 3 2 1 |
| Bit Number: | 7 6 5 4 3 2 1 0 |
| Required Bit Setting: | 0 0 1 0 0 1 1 0 |
| Binary Code: | 100110 |
| NR1 Format Decimal Number
Code to be entered: | 38 |
- 21 NR1 format codes can be entered as single digit numbers, two digit numbers or three digit numbers; e.g. 38, 038, 005, 05, 5, 120 etc.

TABLE 5.6**Status Byte and Service Request Enable Registers**

DIO Line	Bit	Function
1	0	Not used - always logic 0
2	1	Not used - always logic 0
3	2	Not used - always logic 0
4	3	'1' = Summary of Device Event Status Register showing one or more logic 1s
5	4	'1' = Response message available
6	5	'1' = Summary of Standard Event Status Register showing one or more 1s
7	6	'1' = Service requested
8	7	Not used - always logic 0

TABLE 5.7

Standard Event Status and Enable Registers

DIO Line	Bit	Function
1	0	'1' = Operation Complete
2	1	Not used - always logic 0
3	2	'1' = Query Error (see NOTE 1)
4	3	Not used - always logic 0
5	4	'1' = Execution Error (see NOTE 2)
6	5	'1' = Command Error (see NOTE 3)
7	6	'1' = User Request (see NOTE 4)
8	7	'1' = Power On (after power interrupt)

NOTE 1:

Error generated either if controller tries to read the Output Queue when no output is available or data in the Output Queue is lost.

NOTE 2:

Error generated either if data associated with a particular command header is out of range, of the wrong type for a particular command, or if a valid program message could not be executed.

NOTE 3:

Command Error can be as a result of one of the following:

- (1) Syntax error.
- (2) Device has received an unrecognized or unimplemented header.
- (3) 'GET' message has occurred within a program message.
- (4) The command string will be correctly executed up to the point the error occurs. The remaining string up to the next command separator (;), or a valid program message terminator, will be ignored. Execution will continue as normal after reception of either of these delimiters.

NOTE 4:

Set to logic 1 when local control is requested by pressing the LOCAL key on the instrument front panel provided Local Lockout has not been sent.

TABLE 5.8

Device Defined Event Status and Enable Registers

DIO Line	Bit	Function
1	0	'1' = Indicates change of standard
2	1	Not used - always logic 0
3	2	Not used - always logic 0
4	3	'1' = Result out of range (see NOTE 1)
5	4	'1' = Internal counters overflow (see NOTE 2)
6	5	'1' = Local Oscillator out of lock (see NOTE 3)
7	6	'1' = Check mode error (see NOTE 4)
8	7	Not used - always logic 0

NOTE 1:
ER 02 on the display.

NOTE 2:
ER 03 on the display.

NOTE 3:
ER 04 on the display.

NOTE 4:
ER 50 on the display.

EXPLANATION OF RESPONSE TO INTERFACE MESSAGES

- 22 The instrument will respond to all valid device-dependent commands which are received after it has been addressed to listen. Device- dependent commands are recognized as such because they are transmitted with the attention (ATN) message false.
- 23 The instrument also responds to a number of multi-line interface messages. These are recognized because they are transmitted with the ATN message true. TABLE 5.9 gives the instrument's response to different bus messages. The following paragraphs detail the instrument's response to these messages. Any multi-line message not specifically mentioned is hand-shaken, but is otherwise ignored.

Address Messages

- 24 The instrument responds to address messages defined by the setting of the address switches, A1 to A5, on the rear panel. If these are set to 31 then the Address will default to 0.
- 25 On receipt of its listen address, the instrument becomes a listener. If it has been previously addressed to talk it ceases to act as a talker. If in the local control state when the address is received, the instrument goes to the remote control state provided that the REN message is true.
- 26 On receipt of its talk address, the instrument becomes a talker. If it has previously been addressed to listen it ceases to act as a listener. If in the local control state when the address is received, it will remain under local control.
- 27 If the instrument has been addressed to talk, and then receives the talk address of another device, it ceases to act as a talker.

Local Lockout

- 28 The instrument will respond to the local lockout (LLO) message regardless of its address state. The return-to-local function of the RESET/CONTINUE (Local) key on the front panel is disabled (the RESET/CONTINUE function remains enabled when in local control).
- 29 Local lockout is cleared by sending the remote enable (REN) message false. This returns all devices on the bus to the local control state.

Device Clear and Selected Device Clear

- 30 The instrument responds to the device clear (DCL) message and the selected device clear (SDC) message. It will only respond to the SDC message if it is a listener, but will respond to the DCL message regardless of its addressed state.
- 31 The instrument responds to either message by clearing any device dependent commands in its input buffer and any response message in the output queue.

TABLE 5.9

Response to Bus Messages

Message	Addressed State	Instrument Response
Address	Any	<p>For listen address: Becomes a listener and goes to the remote control state. If previously addressed to talk, ceases to act as a talker.</p> <p>For talk address: Becomes a talker. If previously addressed to listen, ceases to be a listener.</p> <p>For talk address of another device: If previously addressed to talk, ceases to be a talker.</p>
Local Lockout (LLO)	Any	LOCAL key disabled. (Cleared by sending the REN message false).
Device Clear (DCL)	Any	Clears any pending message in the Input Buffer and any response messages in the Output Queue.
Selected Device Clear (SDC)	Listen	As above.
Serial Poll Enable (SPE)	Any	Enters the serial poll mode state (SPMS). If addressed to talk while in this state, sends the status byte.
Serial Poll Disable (SPD)	Any	Enters the serial poll idle state (SPIS). If addressed to talk while in this state, sends data in the output message format.
Group Execute Trigger (GET)	Listen, and no measurement cycle in progress.	Triggers a measurement without command processing overhead and only after the Input Buffer is empty.
Go to Local (GTL)	Listen	Reverts to local control.
Untalk Unlisten	Talk Listen	<p>Ceases to be a talker.</p> <p>Ceases to be a listener.</p> <p>The ADDR indicator turned off.</p>

Serial Poll Enable and Serial Poll Disable

- 32 The instrument responds to the Serial Poll Enable (SPE) message and the Serial Poll Disable (SPD) message regardless of its addressed state.
- 33 The instrument responds to the SPE message by entering the serial poll mode state (SPMS). If the instrument is addressed to talk while in this state, it will put the status byte onto the bus instead of its normal data output string.
- 34 The instrument responds to the SPD message by leaving the SPMS and entering the serial poll idle state (SPIS). If the instrument is addressed to talk while in this state, it will put its data output string onto the bus provided data is available in the output buffer.

Group Execute Trigger

- 35 The instrument responds to the Group Execute Trigger (GET) message provided it is a listener and no measurement cycle is in progress. Except for the inability to retrigger during a measurement cycle, the response to the GET message is the same as to the common command *TRG.

Go to Local

- 36 The instrument responds to the Go to Local (GTL) message provided that it is a listener. The instrument reverts to the local control state, but remains addressed to listen. It return to remote control on receipt of the first byte of a device-dependent command.

Untalk and Unlisten

- 37 If addressed to talk, the instrument will go to the talker idle state (TIDS) on receipt of the untalk message. If addressed to listen, it will go to the listener idle status (LIDS) on receipt of the unlisten message. The ADDR indicator will be turned off.

INPUT COMMAND CODES

- 38 When the instrument is addressed it can be controlled by means of common commands given in Table 5.10 and device-dependent commands given in Table 5.11.

MESSAGE PROTOCOL AND SYNTAX

- 39 The IEEE 488.2 protocol provides a communication medium, using different types of messages, between a controller and controlled devices (i.e. Measuring instruments such as the Dana 2101 Microwave Counter). This medium is passed between controller and device via the GPIB Interface Bus.
- 40 The IEEE 488.2 Standard lays down hard and fast rules for message construction and content (referred to as PROTOCOL and SYNTAX).

System Message Traffic

- 41 Messages passed between controller and device consist of the following types:
- (1) Program Messages - passed from controller to device. Program messages contain commands telling the device to do something, queries asking the device for data and status information, and data for setting device operating parameters. The device is defined as a LISTENER.
 - (2) Response Messages - Passed from device to controller. Response messages contain responses to queries and commands, data containing error information and results from measurements taken. The device is defined as a TALKER.
- 42 An example of the device as a listener is shown as follows:

Controller sends the command:	Device interprets and acts upon the command by selecting:
'FRQA'	'FRQA'

- 43 An example of the device as a talker is shown as follows:

Controller sends the query:	Device responds by sending the answer to the controller:
'GATE?'	'1' (indicating that the gate is open)

NOTE: In this example the device has first acted as a listener to enable it to receive the query, then acted as a talker to send the answer back to the controller as a response message.

Program Messages

- 44 Program messages are made up of Program Message Units (PMUs), PMU Separators (;) and a Program Message Terminator (PMT), see TABLE 5.12 Permitted Terminators. A program message is constructed as follows:

PMU ; PMU ; PMU ; PMU ; PMU PMT

- 45 Each PMU within the message is made up of a PMU Header (a mnemonic of ASCII characters), a Header separator (a white space character), Data and Data separators (,). A PMU is constructed as follows:

HEADER [] DATA , DATA , DATA , DATA ;

NOTE: In this example the white space character is represented by square brackets []. Text spaces shown in the preceding and following examples are included for clarity only, no spaces in messages are to be used except where indicated by the square brackets.

- 46 This device accepts Program Messages into a buffer that can hold 10 string characters or 20 numerical characters.

Response Messages

- 47 Response messages are constructed in a similar manner to program messages. Response messages consist of Response Message Units (RMUs), RMU Separators (;) and a Response Message Terminator (RMT). The RMT is always the NL (or LF) character with EOI. A response message is constructed as follows:

RMU ; RMU ; RMU ; RMU ; RMU RMT

- 48 This device can store, in the Output Queue, five Response Message Units.
- 49 Each RMU within the message is made up of a RMU Header (a mnemonic of ASCII characters), a Header separator (a white space character), Response Data and Response Data separators (,). A RMU is constructed as follows:

HEADER [] RESPONSE DATA , RESPONSE DATA , RESPONSE DATA ;

NOTE: In this example the white space character is represented by square brackets [].

White Space Character

- 50 The white space character may be any ASCII encoded byte in the ranges of 0 to 9 and 11 to 32 inclusive. The most commonly used white space character is the space character (ASCII encoded byte 32) as generated by a QWERTY keyboard space bar.

OVERLAPPED/SEQUENTIAL COMMANDS

- 51 Every device-dependent command is defined as either sequential or overlapped.
- 52 A sequential command is started and completed before the succeeding command is executed.
- 53 An overlapped command is started but not necessarily completed before the succeeding command is started.
- 54 The synchronization commands (*WAI, *OPC, *OPC?) can be used to either control or indicate when the commands have been completed.

TABLE 5.10a

Common Commands

Code	Function	Explanation
*IDN?	Identification Query	<p>Puts into the Output Queue a unique identification of the device. Response is divided into four fields separated by commas:</p> <p>Field 1 - Manufacturer</p> <p>Field 2 - Model number</p> <p>Field 3 - ASCII character 0</p> <p>Field 4 - Software details</p> <p>NOTE: This Query should be the last Query message in any terminated message.</p>
*RST	Reset	Sets device dependent functions to their power-up state.
*TST?	Self Test Query	Performs all tests not needing operator intervention. If all checks pass then ASCII 0 is placed in the Output Queue. If checks fail then the relevant number is placed in the Output Queue. The number output is in NR1 format.
*OPC	Operation Complete Command	Causes the instrument to generate the operation complete message in the Standard Event Status Register when all pending selected device operations are completed.
*OPC?	Operation Complete Query	As above, but places an ASCII 1 into the Output Queue instead of setting the operation complete message. NR1 format.
*WAI	Wait-to-continue Command	The instrument is prevented from executing any further commands or queries until there are not operations pending.

TABLE 5.10b

Common Commands (Continued)

Code	Function	Explanation
*CLS	Clear Status Command	Clears the Standard Event Register and the Device Event Register.
*ESE	Standard Event Status Enable Command	Sets the Standard Event Status Enable Register bits. Must be followed by decimal numeric data of NR1 format in the range 0 to 255. This register determines which standard events will be reported to the Status Byte Register.
*ESE?	Standard Event Status Enable Query	Causes the instrument to put the current contents of the Standard Event Status Enable Register into the Output Queue. NR1 format.
*ESR?	Standard Event Status Register Query	Causes the instrument to put the current contents of the Standard Event Status Register into the Output Queue. This also clears the register. NR1 format.
*SRE	Service Request Enable Command	Sets the Service Request Enable Register bits. Must be followed by decimal numeric data of NR1 format in the range 0 to 255. When bits are set in this register, and provided that the corresponding summary bits in the Status Register are set, SRQ will be generated.
*SRE?	Service Request Enable Query	Causes the instrument to place the contents of the Service Request Enable Register into the Output Queue. NR1 format.
*STB?	Status Byte Query	Causes the instrument to place the contents of the status byte into the Output Queue. NR1 format. This returns the same value as a serial poll with the exception of bit 6 which is a summary of all other bits in the status byte.
*TRG	Trigger Command	Causes the instrument to trigger a measurement. Any existing measurement is aborted.

TABLE 5.11a

Device Dependent Commands

Code	Function	Explanation
<u>Measurement Functions</u>		
FRQA	Selects INPUT A	This command sent with required resolution. If resolution missing previous resolution used. Overlapped command (See NOTE 1).
FRQB	Selects INPUT B	This command sent with required resolution. If resolution missing previous resolution used. Overlapped command (See NOTE 1).
FRQC	Selects INPUT C	This command sent with required resolution. If resolution missing previous resolution used. Overlapped command (See NOTE 1).
CHECK	Selects 10 MHz check	This command sent with required resolution. If resolution missing previous resolution used. Overlapped command (See NOTE 1).
RABA	Selects Ratio of INPUT B to INPUT A	This command sent with required resolution. If resolution missing previous resolution used. Overlapped command (See NOTE 1).
RACA	Selects Ratio of INPUT C to INPUT A	This command sent with required resolution. If resolution missing previous resolution used. Overlapped command (See NOTE 1).
RACB	Selects Ratio of INPUT C to INPUT B	This command sent with required resolution. If resolution missing previous resolution used. Overlapped command (See NOTE 1).

TABLE 5.11b

Device Dependent Commands (Continued)

Code	Function	Explanation
<u>Measurement Control</u> HOLD MEAS? MEAS:CONT? DISP?	Selects HOLD Mode	The current reading is held in the display until another reading is triggered. Overlapped command (See NOTE 1).
	New reading cycle	Causes the instrument to abandon the current reading, start a new reading cycle and place the calculated result into the Output Queue. Overlapped command (See NOTE 1).
	Continuous stream of readings	Causes the instrument to take a continuous stream of readings and place them in the Output Queue. Each measurement is separated by ',' and no terminator is sent. When a new program message is sent this will generate a query error which cancels the MEAS:CONT? command. Overlapped command (See NOTE 2).
	Current displayed value placed in Output Queue	If this command is repeated without another measurement taking place or the display is reset, then a zero is placed in the Output Queue. DISP? is used with *TRG or GET with the instrument in HOLD Mode. If HOLD Mode is off the display is continuously updated and the results of *TRG or GET is lost. Sequential command.

TABLE 5.11c

Device Dependent Commands (Continued)

Code	Function	Explanation
<u>Measurement Control (Continued)</u>		
MAN	Controls Manual acquisition mode	<p>This mode can be switched ON or OFF. Values can be stored in the MANUAL Store. One of these two parameters must be specified otherwise a command error is generated.</p> <p>If MAN ON is selected then TRACK ON or LOWFM ON commands are automatically disabled. When MAN OFF is selected then TRACK and LOWFM revert to their previous states.</p> <p>Allowed range 495 MHz - 26.505 GHz. Overlapped command (See NOTE 1).</p>
LOWFM	Sets LOW FM to ON or OFF	<p>This command switches the Low FM function ON or OFF in automatic acquisition mode.</p> <p>Selecting LOW FM when TRACK is ON disables TRACK function.</p> <p>Overlapped command (See NOTE 1).</p>
TRACK	Sets TRACK to ON or OFF	<p>This command switches the Track function ON or OFF in the acquisition mode.</p> <p>Selecting TRACK when LOWFM is ON disables LOWFM.</p> <p>Overlapped command (See NOTE 1).</p>
OFFSET	Controls OFFSET function	<p>Two parameters can be specified, first, the number to be stored, second, switching OFFSET to ON or OFF. If no parameters are specified then a command error is generated.</p> <p>Allowed range of the numerical input or displayed value is: $\pm 999.999999999 \times 10^9$</p> <p>Overlapped command (See NOTE 1).</p>

TABLE 5.11d

Device Dependent Commands (Continued)

Code	Function	Explanation
<u>Measurement Control</u> (Continued)		
MULT	Control Multiplier function	<p>Two parameters can be specified, first, the number to be stored, second, switching MULT to ON or OFF. If no parameters are specified then a command error is generated.</p> <p>Allowed range of the numerical input or displayed value is: $\pm 999.999999999 \times 109$.</p> <p>Overlapped command (See NOTE 1).</p>
SAMPLE	Controls display sample rate	<p>This function enables the read rate to be varied by specifying a display hold time. The allowed range is 0 to 10 seconds, numbers are rounded to the nearest 10mS.</p> <p>Sequential command.</p>
DUMP	Controls Dump mode	<p>The following modes are forced when DUMP Mode is enabled:</p> <p>FREQ C - selected if any ratio or check is selected, 10 kHz resolution. When DUMP Mode is disabled the selected function will be enabled.</p> <p>FREQ A & B - 4 digits resolution.</p> <p>MULT - OFF.</p> <p>OFFSET - OFF.</p> <p>ALL SPECIAL FUNCTIONS - disabled except 11, 41, 42, 43, 61 (VXI only), and 71.</p> <p>DUMP MODE CONDITIONS:</p> <p>When activated display is blanked and not further update occurs until DUMP is disabled.</p> <p>MEAS:CONT? - used to start a stream of continuous readings at maximum speed.</p> <p>MEAS?, *TRG and GET commands may be used with DUMP, but returns only one measurement result.</p> <p>Overlapped command (See NOTE 1).</p>

TABLE 5.11e

Device Dependent Commands (Continued)

Code	Function	Explanation
<u>Query Commands</u>		
MAN?	Manual store contents query	Places the contents of the Manual Store in the Output Queue. NR3 format. Sequential command.
OFFSET?	Offset store contents query	Places the contents of the Offset Store in the Output Queue. NR3 format. Sequential command.
MULT?	Multiplier store contents query	Places the contents of the Multiplier Store in the Output Queue. NR3 format. Sequential command.
SF?	Special Function query	Places the Special Functions status in the Output Queue. Sequential command.
SAMPLE?	Sample store contents query	Places the contents of the Sample Store in the Output Queue. NR1 format. Sequential command.
STD?	Standard in use query	Puts a numerical value in the Output Queue according to the standard in use: '1' = Internal standard '0' = External standard. NR1 format. Sequential command.
ESR?	Device Event Register query	Places the contents of the Device Event Register into the Output Queue, the register is then cleared. NR1 format. Sequential command.

TABLE 5.11f

Device Dependent Commands (Continued)

Code	Function	Explanation
<u>Query Commands</u> (Continued)		
ESE?	Device Event Status Enable Register query	Places the contents of the Device Event Status Enable Register into the Output Queue. NR1 format. Sequential command.
GATE?	Gating status query	Places a numerical value in the Output Queue according to the status of the gate signal: '0' = Gate closed '1' = Gate open. NR1 format. Sequential command.
LO?	Local Oscillator store query	Places the contents of the Local Oscillator store into the Output Queue. NR1 format. Sequential command.
HN?	Harmonic Number store query	Places the contents of the Harmonic Number store into the Output Queue. NR1 format. Sequential command.
<u>General Commands</u>		
FP	Front Panel display control	When OFF is selected the display is blanked. This command is only disabled by using the command with ON parameter or switching the instrument off then on again. Sequential command.
LO	Local Oscillator setting	Sets the value of the Local Oscillator when SF41 is active. Allowed range of the numerical or displayed value is 294.0 MHz to 354.0 MHz. Numbers are rounded to the nearest 0.1 MHz. Sequential command.

TABLE 5.11g

Device Dependent Commands (Continued)

Code	Function	Explanation
<u>General Commands</u> (Continued)		
HN	Harmonic Number setting	Sets the value of the Harmonic Number when SF41 is active. Allowed range of the numerical or displayed value is ± 2 to ± 90 . Numbers are rounded to the nearest integer. Sequential command.
ESE	Device Defined Event Status Enable Command	Sets the Device Defined Event Status Enable Register. Allowed range of numbers is 0 to 255. NR1 format. Sequential command.
SF	Controls Special Functions	'OFF' turns the Special Functions off but preserves those selected. 'ON' switches on those Special Functions. Overlapped command (See NOTE 1).

NOTE 1:

These overlapped commands are defined as complete when the gate control circuit is armed, or if **FREQ C** is in use, the acquisition cycle has commenced.

NOTE 2:

This overlapped command is defined as complete when the result is placed into the Output Queue. If the compound command **CONT** is used, the command is still complete at the same time but only at the first result received. If **MULT MEAS?** is used in the same string then the operation complete flag will be set when the first **MEAS?** is complete.

TABLE 5.12

Permitted Terminators

1	2	3
LF	LF EOI true	Last Character EOI true

NOTE:

LF = Line Feed

EOI = END or IDENTITY

TABLE 5.13**Numerical Input Format**

Byte No	Interpretation	Permitted ASCII Characters
1	Sign of Mantissa	+ or -
2	Most Significant Digit	0 to 9 or .
3	Digit	0 to 9 or .
4	Digit	0 to 9 or .
5	Digit	0 to 9 or .
6	Digit	0 to 9 or .
7	Digit	0 to 9 or .
8	Digit	0 to 9 or .
9	Digit	0 to 9 or .
10	Digit	0 to 9 or .
11	Digit	0 to 9 or .
12	Digit	0 to 9 or .
13	Digit	0 to 9 or .
14	Least Significant Digit	0 to 9 or .
15	Character has no meaning	White Space
16	Exponent Indicator	E
17	Character has no meaning	White Space
18	Sign of Exponent	+ or -
19	More Significant Digit	0 to 9
20	Digit	0 to 9
21	Digit	0 to 9
22	Digit	0 to 9
23	Least Significant Digit	0 to 9

NOTE 1:

At least one exponent digit must be used if 'E' (bit 16) is present.

NOTE 2:

The numerical input format conforms to IEEE 488.2 and is based on NR1, NR2 and NR3 formats. Any number input that deviates from these formats will generate a command error. If the number is out of range for a particular command header, then an execution error is reported. For some commands the resolution of the mantissa is limited.

TABLE 5.14

Gate Times for FREQUENCIES A and B

Number of digits in FREQ A, FREQ B & CHECK	Gate Time	Resolution Number
10	20 s	10
9	1 s	9
8	100 ms	8
7	10 ms	7
6	1 ms	6
5	1 ms	5
4	1 ms	4
3	1 ms	3

TABLE 5.15

Gate Times for FREQUENCY C

Frequency GHz	Resolution			
	1 Hz	10 Hz	100 Hz	1 kHz
0.5 - 1.0	100 ms	10 ms	1 ms	1 ms
1.0 - 4.0	200 ms	20 ms	2 ms	1 ms
4.0 - 8.0	400 ms	40 ms	4 ms	1 ms
8.0 - 12.0	600 ms	60 ms	6 ms	1 ms
12.0 - 16.0	800 ms	80 ms	8 ms	1 ms
16.0 - 20.0	1 s	100 ms	10 ms	1 ms

TABLE 5.16

Special Function Codes

Function	Code
Deselects Channel A filter	10
Selects Channel A filter	11
Cancels Smooth function	20
Selects Smooth function (See NOTE 1)	21
Cancels all group 30 special functions	30
Displays Local Oscillator Value (See NOTE 2)	31
Displays Intermediate Frequency (See NOTE 3)	32
Displays Harmonic Number as an integer (See NOTE 3)	33
Displays Harmonic Number with fractional part (See NOTE 3)	34
Displays IF Detector Status (See NOTEs 3 & 4)	35
Displays LP Filter Status (See NOTEs 3 & 4)	36
Displays LO Lock Line Status (See NOTE 7)	37
Cancels all group 40 special functions	40
Allows setting of LO & Harmonic Number (See NOTEs 3 & 5)	41
Switches LO Off under all conditions (Quiet Mode)	42
Disables IF output under all conditions	43
Cancels all group 50 special functions	50
Ignore IF level detector	51
Cancels all group 70 special functions	70
Initiates front panel display checks	71
	72
These codes are reserved for diagnostic purposes and are described in the Maintenance Manual (See NOTE 6)	73
	74
	75
Leading (function) letters in O/P string	80
No leading (function) letters in O/P string	81
Cancels group 90 special functions	90
Enables hardware ratio B/A	91

NOTE 1: This function does not operate on diagnostic special functions.

NOTE 2: This function only operates during INPUT C measurements and displays the Local Oscillator selected to make a measurement.

NOTE 3: Operates under same conditions as Special Function 31.

NOTE 4: '0' displayed = Detector False.
 '1' displayed = Detector True.

(Special Function 41 must also be active).

NOTE 5: MANUAL LED is on, LO and Harmonic Number (HN) store both active. To access LO use TRACK key, to access HN use LOWFM key.

NOTE 6: Special Functions 71 to 75 can be entered into the special functions register at any time. They are active only when the instrument is in Check Mode.

NOTE 7: '0' displayed = In lock, '1' displayed = Out of Lock.

TABLE 5.17

Special Function Request (SF?) Response Format

SF Groups >	10	20	30	40	50	60	70	80	90
Response Format >	n	,	n	,	n	,	n	,	n

TABLE 5.18

Alphabetic List of Required Command Codes

Code	Function	Code	Function
*CLS	Clear status	*OPC?	Operation Complete Query
*ESE	Standard Event Status Event	*RST	Reset
*ESE?	Standard Event Status Event Query	*SRE	Service Request Enable
*ESR?	Standard Event Status Query	*SRE?	Service Request Enable Query
*IDN?	Identification Query	*STB	Status Byte Query
*OPC	Operation Complete	*TST	Self Test Query
		*WAI	Wait to Continue

TABLE 5.19

Alphabetic List of Optional Command Codes

Code	Function	Code	Function
o s o s s s o o o s s s o s s o s s	CHECK DISP? DUMP ESE ESE? ESR? FP FREQA FREQB GREQC GATE? HN HN? HOLD LO LO?	LOWFM MAN MAN? MEAS? MEAS: CONT? MULT MULT? OFFSET OFFSET? RABA RACA RACB SAMPLE SAMPLE? SF SF? STD? TRACK *TRG	Controls 10MHz check Displays value in output queue Control DUMP mode Device Event Status Enable Device Event Status Register query Device Event Register query Front panel display control Selects INPUT A Selects INPUT B Selects INPUT C Gating status query Harmonic number setting Harmonic number store query Selects HOLD mode Local oscillator setting Local oscillator store query Controls Low FM Controls manual select Manual store query New reading cycle Continuous stream of readings Controls Multiplier MULT store query Controls Offset Offset store query Selects RATIO B/A Selects RATIO C/A Selects RATIO C/B Controls display sample rate Sample store query Controls Special Functions SF query Standard in-use query Controls Track Trigger command

NOTE:
o denotes an overlapped command.
s denotes a sequential command.